



INSTALL GUIDE

FLC-CH(RS)-CH4-EN

DOCUMENT NUMBER
11992

REVISION DATE
20130911

FIRMWARE
FLC-CH(RS)-CH4

HARDWARE
FLRSCH4

ACCESSORIES
FLPROG (REQUIRED)
FLRF1 (OPTIONAL)
FLRF2 (OPTIONAL)
CARLINK ASCL2 (OPTIONAL)

NOTICE The manufacturer will accept no responsibility for any electrical damage resulting from improper installation of this product, be that either damage to the vehicle itself or to the installed device. This device must be installed by a certified technician. Please review the Installation Guide carefully before beginning any work.



BEFORE INSTALLATION

- 1- Connect module to computer
- 2- Login to Weblink account
- 3- Flash firmware to module (module is not preloaded with firmware)
- 4- Use accessories accordingly (accessories are sold separately)

MAKE	MODEL	YEAR	INSTALL TYPE	FEATURES																
				DATA IMMOBILIZER BYPASS	3X LOCK REMOTE START	PRIORITY UNLOCK	DOOR LOCK	DOOR UNLOCK	ARM OEM ALARM	DISARM OEM ALARM	TRUNK/HATCH RELEASE	POWER LIFTGATE	POWER SLIDING DOOR (L)	POWER SLIDING DOOR (R)	DATA/MUX IGNITION CTRL	RAP SHUTDOWN CTRL	HOOD STATUS (W/OEM SW)	DOOR STATUS	BRAKE PEDAL STATUS	TACHOMETER STATUS
CHRYSLER	300 AT	08-10	1	•	•	•	•	•	•	•	•				•	•	•	•	•	•
	300 Limited AT	08-10	1	•	•	•	•	•	•	•	•				•	•	•	•	•	•
	300c AT	08-10	1	•	•	•	•	•	•	•	•				•	•	•	•	•	•
	300c SRT8 AT	08-10	1	•	•	•	•	•	•	•	•				•	•	•	•	•	•
	Town & Country AT	08-13	1	•	•	•	•	•	•	•	•		•	•	•	•	•	•	•	•
DODGE	Caravan AT	08-10	1	•	•	•	•	•	•	•	•		•	•	•	•	•	•	•	•
	Challenger SXT AT	08-13	1	•	•	•	•	•	•	•	•				•	•	•	•	•	•
	Challenger R/T AT	08-13	1	•	•	•	•	•	•	•	•				•	•	•	•	•	•
	Challenger SRT8 AT	08-13	1	•	•	•	•	•	•	•	•				•	•	•	•	•	•
	Charger SE AT	08-10	1	•	•	•	•	•	•	•	•				•	•	•	•	•	•
	Charger R/T AT	08-10	1	•	•	•	•	•	•	•	•				•	•	•	•	•	•
	Charger SRT8 AT	08-10	1	•	•	•	•	•	•	•	•				•	•	•	•	•	•
	Durango AT	11-13	1	•	•	•	•	•	•	•	•				•	•	•	•	•	•
	Grand Caravan AT	08-13	1	•	•	•	•	•	•	•	•		•	•	•	•	•	•	•	•
	Journey AT	09-10	1	•	•	•	•	•	•	•	•				•	•	•	•	•	•
	Magnum AT	08	1	•	•	•	•	•	•	•	•				•	•	•	•	•	•
	RAM 1500 AT	09-12	1	•	•	•	•	•	•	•	•				•	•	•	•	•	•
	RAM 2500 AT	10-12	1	•	•	•	•	•	•	•	•				•	•	•	•	•	•
	RAM 3500 AT	10-12	1	•	•	•	•	•	•	•	•				•	•	•	•	•	•
	JEEP	Commander AT	08-10	1	•	•	•	•	•	•	•	•				•	•	•	•	•
Grand Cherokee AT		08-13	1	•	•	•	•	•	•	•	•				•	•	•	•	•	•
RAM	C/V AT	10-13	1	•	•	•	•	•	•	•	•		•	•	•	•	•	•	•	•
	1500 AT	10-12	1	•	•	•	•	•	•	•	•				•	•	•	•	•	•
	2500 AT	10-12	1	•	•	•	•	•	•	•	•				•	•	•	•	•	•
	3500 AT	10-12	1	•	•	•	•	•	•	•	•				•	•	•	•	•	•
VW	Routan AT	09-12	1	•	•	•	•	•	•	•		•	•	•	•	•	•	•	•	•

* May require additional parts.

MAKE	MODEL	YEAR	WIRE DESCRIPTION	CONNECTOR NAME	CONNECTOR COLOR	CONNECTOR TYPE	POSITION	WIRE COLOR	POLARITY	MODULE LOCATION	COMPONENT LOCATOR
CHRYSLER	300	08-10	Parking Light	D2242	Black	10 pin	1	White/Brown	(MUX)	Switch	~
			Driver Door Pin	~	~	~	~	Purple	(-)	Driver kick panel	~
	300 Limited	08-10	Parking Light	D2242	Black	10 pin	1	White/Brown	(MUX)	Switch	~
			Driver Door Pin	~	~	~	~	Purple	(-)	Driver kick panel	~
	300C	08-10	Parking Light	D2242	Black	10 pin	1	White/Brown	(MUX)	Switch	~
			Driver Door Pin	~	~	~	~	Purple	(-)	Driver kick panel	~
	300 SRT8	08-10	Parking Light	D2242	Black	10 pin	1	White/Brown	(MUX)	Switch	~
			Driver Door Pin	~	~	~	~	Purple	(-)	Driver kick panel	~
	Town & Country	08-10	Parking Light	D2242	Black	10 pin	1	White/Brown	(MUX)	Switch	~
			Driver Door Pin	~	~	~	~	Purple	(-)	Driver kick panel	~
	Town & Country	11-13	Parking Light	D2242	Black	6 pin	3	White/Green	(MUX)	Switch	~
			Driver Door Pin	~	~	~	~	Purple	(-)	Driver kick panel	~
DODGE	Caravan	08-10	Parking Light	D2242	Black	10 pin	1	White/Brown	(MUX)	Switch	~
			Driver Door Pin	~	~	~	~	Purple	(-)	Driver kick panel	~
	Challenger R/T	08-13	Parking Light	D2242	Black	10 pin	1	White/Brown	(MUX)	Switch	~
			Driver Door Pin	~	~	~	~	Purple	(-)	Driver kick panel	~
	Challenger SXT	08-13	Parking Light	D2242	Black	10 pin	1	White/Brown	(MUX)	Switch	~
			Driver Door Pin	~	~	~	~	Purple	(-)	Driver kick panel	~
	Challenger SRT8	08-13	Parking Light	D2242	Black	10 pin	1	White/Brown	(MUX)	Switch	~
			Driver Door Pin	~	~	~	~	Purple	(-)	Driver kick panel	~
	Charger SE	08-10	Parking Light	D2242	Black	10 pin	1	White/Brown	(MUX)	Switch	~
			Driver Door Pin	~	~	~	~	Purple	(-)	Driver kick panel	~
	Charger R/T	08-10	Parking Light	D2242	Black	10 pin	1	White/Brown	(MUX)	Switch	~
			Driver Door Pin	~	~	~	~	Purple	(-)	Driver kick panel	~
	Charger SRT8	08-10	Parking Light	D2242	Black	10 pin	1	White/Brown	(MUX)	Switch	~
			Driver Door Pin	~	~	~	~	Purple	(-)	Driver kick panel	~
	Durango	11-13	Parking Light	D2242	Black	6 pin	1	White/Green	(MUX)	Switch	~
			Driver Door Pin	~	~	~	~	Purple	(-)	Driver kick panel	~
	Grand Caravan	08-10	Parking Light	D2242	Black	10 pin	1	White/Brown	(MUX)	Switch	~
			Driver Door Pin	~	~	~	~	Purple	(-)	Driver kick panel	~
	Grand Caravan	11-13	Parking Light	D2242	Black	6 pin	3	White/Green	(MUX)	Switch	~
			Driver Door Pin	~	~	~	~	Purple	(-)	Driver kick panel	~
Journey	09-10	Parking Light	~	~	~	~	White/Violet	(+)	Driver kick panel	~	
		Driver Door Pin	~	~	~	~	Purple	(-)	Driver kick panel	~	
Magnum	08	Parking Light	D2242	Black	10 pin	1	White/Brown	(MUX)	Switch	~	
		Driver Door Pin	~	~	~	~	Purple	(-)	Driver kick panel	~	

MAKE	MODEL	YEAR	WIRE DESCRIPTION	CONNECTOR NAME	CONNECTOR COLOR	CONNECTOR TYPE	POSITION	WIRE COLOR	POLARITY	MODULE LOCATION	COMPONENT LOCATOR
DODGE	Ram 1500	09-12	Parking Light	D2242	Black	10 pin	01	White	(MUX)	Switch	~
			Driver Door Pin	~	~	~	~	Purple	(-)	Driver kick panel	~
	Ram 2500	10-12	Parking Light	D2242	Black	10 pin	01	White	(MUX)	Switch	~
			Driver Door Pin	~	~	~	~	Purple	(-)	Driver kick panel	~
	Ram 3500	10-12	Parking Light	D2242	Black	10 pin	01	White	(MUX)	Switch	~
			Driver Door Pin	~	~	~	~	Purple	(-)	Driver kick panel	~
JEEP	Commander	08-10	Parking Light	~	~	~	~	Pin #1 of relay #7	(-)	Power module in engine compartment	~
			Driver Door Pin	~	~	~	~	Purple	(-)	Driver kick panel	~
	Grand cherokee	08-13	Parking Light	~	~	~	~	Pin #1 of relay #7	(-)	Power module in engine compartment	~
			Driver Door Pin	~	~	~	~	Purple	(-)	Driver kick panel	~
RAM	C/V	10	Parking Light	D2242	Black	10 pin	01	White/Brown	(MUX)	Switch	~
			Driver Door Pin	~	~	~	~	Purple	(-)	Driver kick panel	~
	C/V	11-13	Parking Light	D2242	Black	6 pin	01	White/Green	(MUX)	Switch	~
			Driver Door Pin	~	~	~	~	Purple	(-)	Driver kick panel	~
	1500	10-12	Parking Light	D2242	Black	10 pin	01	White	(MUX)	Switch	~
			Driver Door Pin	~	~	~	~	Purple	(-)	Driver kick panel	~
	2500	10-12	Parking Light	D2242	Black	10 pin	01	White	(MUX)	Switch	~
			Driver Door Pin	~	~	~	~	Purple	(-)	Driver kick panel	~
	3500	10-12	Parking Light	D2242	Black	10 pin	01	White	(MUX)	Switch	~
			Driver Door Pin	~	~	~	~	Purple	(-)	Driver kick panel	~
VW	Routan	09-12	Parking Light	D2242	Black	10 pin	01	White/Brown	(MUX)	Switch	~
			Driver Door Pin	~	~	~	~	Purple	(-)	Driver kick panel	~

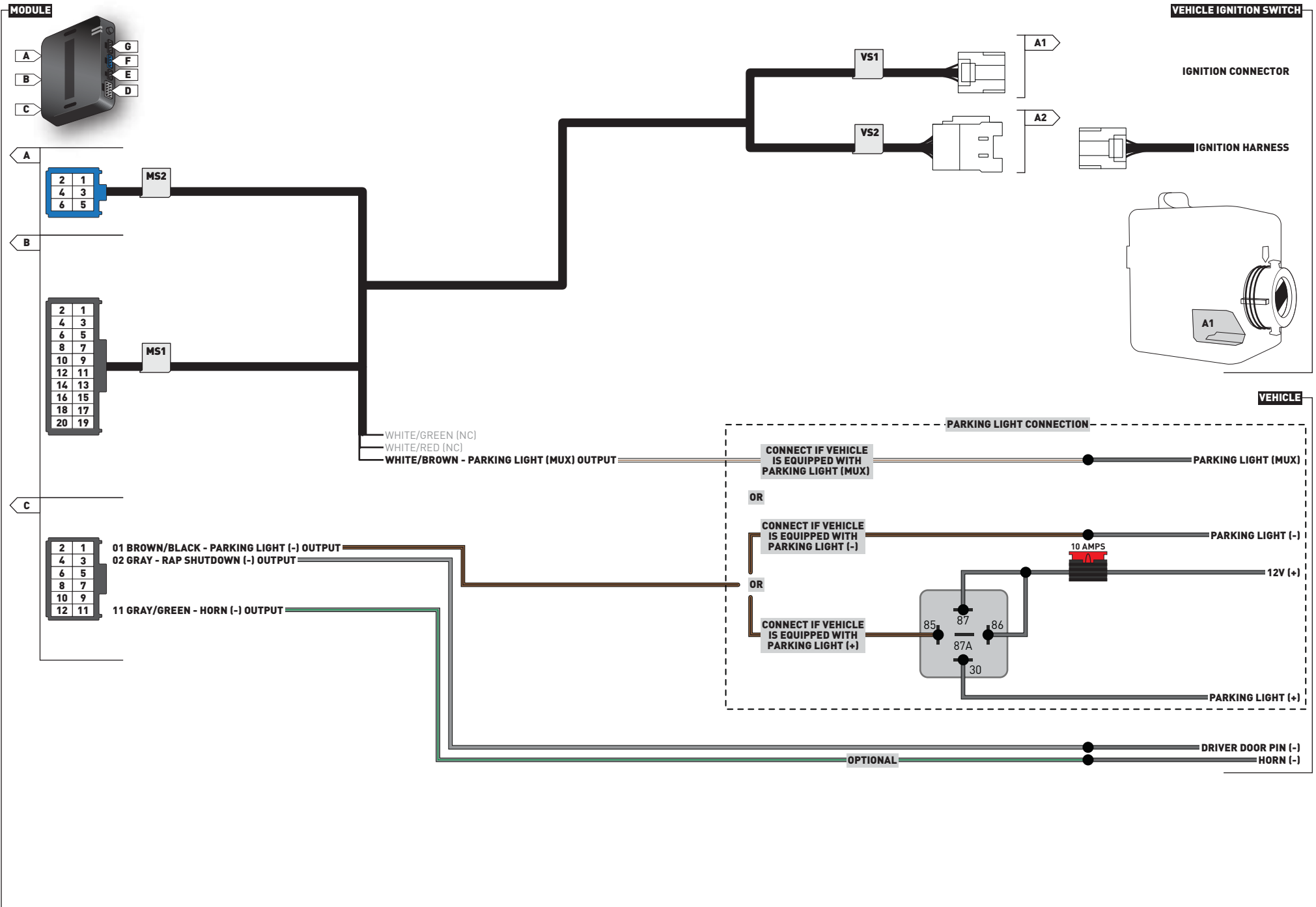

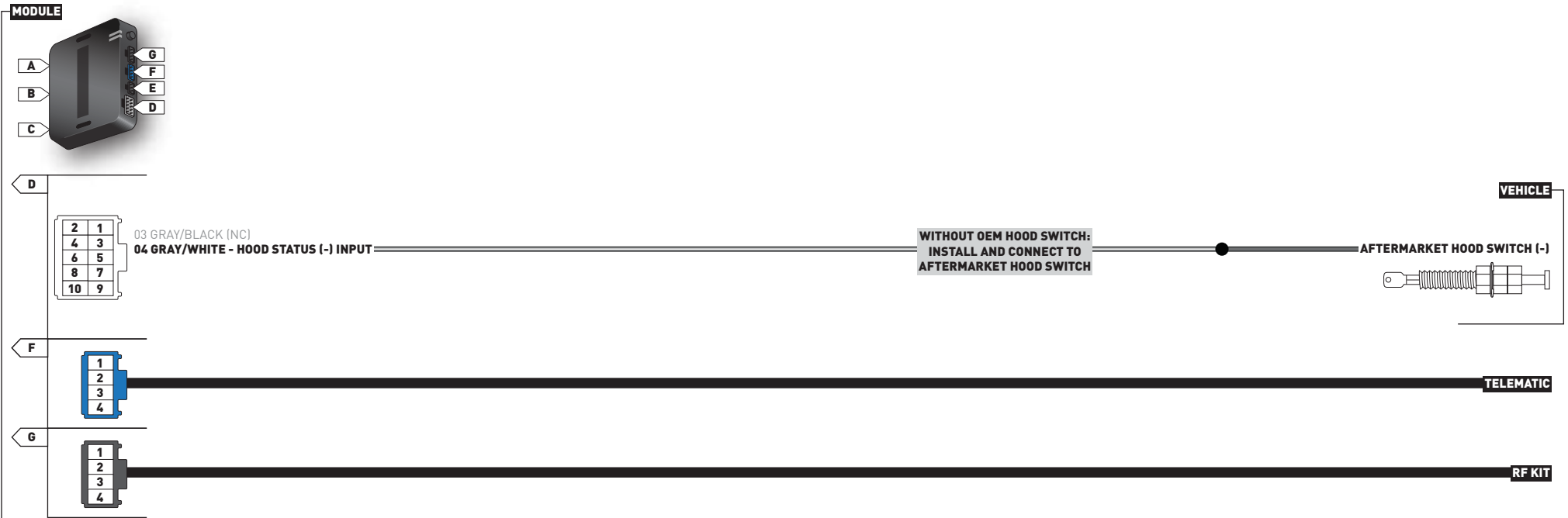

01 Close driver door.



02 Re-open driver door to wake up data bus.



03 Insert key into ignition.



04 Turn key to ON position.



05 LED will turn solid RED.

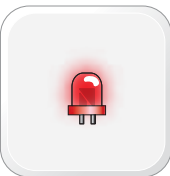

06 Within 5 seconds, LED will flash GREEN rapidly.



07 Turn key to OFF position.



08 Remove key.



09 Press UNLOCK on the OEM remote. If vehicle is not equipped with OEM remote, press module programming button.



10 Wait, LED will turn solid GREEN for 2 seconds.



11 Module Programming Procedure completed.



01 Close driver door.



02 Re-open driver door to wake up data bus.



03 DO NOT PRESS BRAKE PEDAL. Push start button twice [2x] to ON position.



05 LED will turn solid RED.



06 Within 5 seconds, LED will flash GREEN rapidly.



07 DO NOT PRESS BRAKE PEDAL. Push start button once [1x] to OFF position.



09 Press UNLOCK on the OEM remote.



10 Wait, LED will turn solid GREEN for 2 seconds.



11 Module Programming Procedure completed.



>>



NOTE: In Valet Mode, the Remote starter is not functional. Keyless entry, Lock and Unlock will remain functional. See RF kit user manual for alternate valet mode programming.

01



Insert key into ignition.

02



Time restriction. Complete next step within 7 seconds.

03



Turn key to OFF position then to ON position five times [5x] rapidly.

04



Wait, LED 1 will turn solid RED for 2 seconds.

05



Turn key to OFF position.

06



Remove key.

07



Valet Mode Programming Procedure completed.

>>



To exit valet mode: repeat steps 1 to 6.

AFTERMARKET REMOTE PROGRAMMING: NOTES	
<p>I All aftermarket remotes must be programmed to the RF-Kit.</p> <p>Refer to the RF-Kit user guide for aftermarket remote features and programming procedures.</p>	

>>  It is mandatory to exit the Module Navigation at the end of this procedure. Failure to exit the Module Navigation will drain vehicle battery. To exit the Module Navigation at any time: Follow STEP 13.

>>  Module must be programmed to the vehicle.

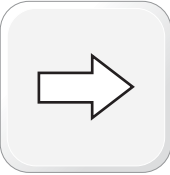
>>  Use the Module Navigation Chart on the next page.

01  Set ignition to OFF position.

02  TO ACCESS THE MENUS: Press and hold programming button until LED 1 turns solid GREEN.

03  IN THE MENUS: Press the programming button as many times as the menu number indicates. LED 1 will flash GREEN an equal amount of times continuously.

04  TO ACCESS THE OPTIONS: Press and hold programming button until LED 1 turns solid RED.

05  IN THE OPTIONS: Press the programming button as many times as the option number indicates. LED 1 will flash RED an equal amount of times continuously.

06  TO ACCESS THE SETTINGS: Press and hold programming button until LED 1 turns solid GREEN.

07  LED 1 will flash GREEN as many times as the current (or default) setting number, continuously.

08  IN THE SETTINGS: Press the programming button as many times as necessary to access your setting. LED 1 will flash GREEN an equal amount of times continuously.

09  To return to the MENUS: exit the Module Navigation and redo the Module Navigation Procedure.

10  To save and return to the OPTIONS: Press and hold programming button until LED 1 turns solid RED.

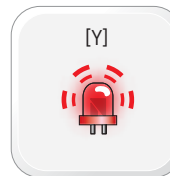
11  LED 1 will flash RED as many times as the current option number continuously.

12  Configure every other setting and proceed to step 13.

13  MANDATORY: EXIT MODULE NAVIGATION. Press and hold programming button for 7 seconds. LED 1 will flash RED rapidly. Release programming button. LED 1 will turn OFF.

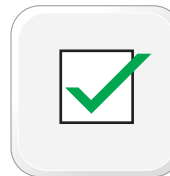
14  Module navigation completed.

>>  Failure to exit the Module Navigation will drain vehicle battery.

MODULE NAVIGATION CHART: NOTES	[X] MENUS		[Y] OPTIONS	[Z] SETTINGS
I Default settings are listed in bold. II Make sure the option is covered on the vehicle before attempting to change the setting.	01	CONFIGURATION	01 DISARM/UNLOCK BEFORE START	01 OFF 02 ON
			02 RELOCK AFTER START	01 OFF 02 ON
			03 RELOCK AFTER SHUTDOWN	01 OFF 02 ON
			04 FORCE UNLOCK ALL ON FIRST PRESS	01 OFF 02 ON
			05 TAKEOVER	01 ENABLE 02 DISABLE*
			06 N/A	01 N/A
			07 FACTORY KEYLESS RS SEQUENCE	01 DISABLE 02 N/A 03 LOCK + UNLOCK + LOCK 04 LOCK + LOCK + LOCK
			08 MODULE RUN TIME	01 03 MIN 02 05 MIN 03 10 MIN 04 15 MIN 05 25 MIN 06 30 MIN 07 35 MIN 08 15 MIN
			09 WAIT TO START DELAY	01 02 SEC 02 05 SEC 03 08 SEC 04 10 SEC 05 15 SEC 06 20 SEC 07 25 SEC 08 30 SEC
			10 N/A	01 N/A
			11 N/A	01 N/A
			12 N/A	01 N/A
			13 N/A	01 N/A

*Vehicle will shutdown when a door is opened.

MODULE NAVIGATION CHART: NOTES	[X] MENUS	[Y] OPTIONS	[Z] SETTINGS								
	01 CONFIGURATION	14 HORN EVENT TRIGGER	<table border="1"> <tr><td>01</td><td>DOUBLE LOCK</td></tr> <tr><td>02</td><td>LOCK + UNLOCK</td></tr> <tr><td>03</td><td>LOCK + UNLOCK + START</td></tr> <tr><td>04</td><td>DOUBLE LOCK + START</td></tr> </table>	01	DOUBLE LOCK	02	LOCK + UNLOCK	03	LOCK + UNLOCK + START	04	DOUBLE LOCK + START
01	DOUBLE LOCK										
02	LOCK + UNLOCK										
03	LOCK + UNLOCK + START										
04	DOUBLE LOCK + START										
		15 HORN CHIRPS WIDTH	<table border="1"> <tr><td>01</td><td>30 mSEC</td></tr> <tr><td>02</td><td>15 mSec</td></tr> <tr><td>03</td><td>60 mSec</td></tr> </table>	01	30 mSEC	02	15 mSec	03	60 mSec		
01	30 mSEC										
02	15 mSec										
03	60 mSec										
	02-07 Technical Support only	01 N/A	01 N/A								

*Vehicle will shutdown when a door is opened.

REMOTE STARTER ERROR CODES: NOTES	[X] NUMBER OF PARKING LIGHT FLASHES	DIAGNOSTIC
I WARNING: The following applies only when the parking lights are connected and supported by the system.	03	Foot brake is ON.
	04	Hood is open.
II After a remote starter failure, the parking lights will flash [X] number times to indicate an error code. See table.	05	Engine tach signal is lost.
	06	System is in Valet Mode.
	07	Vehicle is moving (VSS).
	08	Glow plug timeout error.
	09	RS not synchronized. Start vehicle with OEM key for 15 sec before trying a new RS sequence.
	10	N/A
	11	N/A
	12	N/A
	13	N/A
	14	N/A
	15	N/A
	16	CAN communication failure during RS sequence.

TEST MODULE		LED 1 STATUS	DIAGNOSTIC
I	DURING PROGRAMMING	Flashing RED	Missing/wrong information from firmware or vehicle.
		Solid RED	Module waiting for more vehicle information.
		Flashing GREEN	Additional steps required to complete module programming.
		Solid GREEN then OFF	Module correctly programmed.
		OFF	No activity or module already programmed.
II	DURING REMOTE START	Flashing RED	Module incorrectly programmed.
		Solid RED	Module incorrectly programmed.
		Flashing GREEN	Module correctly programmed and operational.
		Solid GREEN then OFF	Reset in progress.
		OFF	Invalid ground when running status from remote starter.
III	WITH IGNITION OFF	Flashing RED	Module incorrectly programmed or connected.
		Solid RED	Module not programmed. Waiting for more vehicle information.
		Flashing GREEN	False ground when running status from remote starter.
		Solid GREEN then OFF	Reset in progress.
		OFF	Module at rest and ready for a remote start sequence.

01 Disconnect all connectors from module except the BLACK 20-PIN connector.

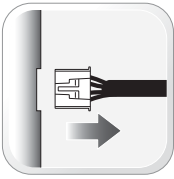

02 Disconnect the BLACK 20-PIN connector.

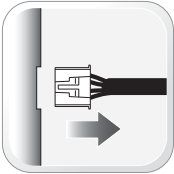

03 PRESS AND HOLD programming button while connecting the BLACK 20-PIN connector.



04 Wait, LED 1 will flash RED. RELEASE programming button.



05 LED 1 will turn RED for 2 seconds.

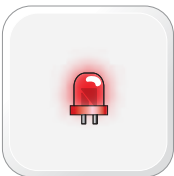

06 Module RESET completed.



07 Reconnect all connectors.

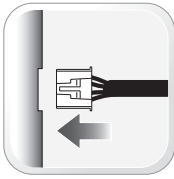

08 Repeat programming procedure.



>> Failure to follow procedure may result with a DTC or a CHECK ENGINE error message.



>>



All vehicle doors must be closed and locked prior to remote start sequence.

01



Press unlock on OEM or aftermarket remote.

02



Insert key into ignition.

03



Turn key to ON position.

04



Press and release BRAKE pedal.

05



Take over procedure completed.

>>



Failure to follow procedure will result in vehicle engine shutdown.

>>



All vehicle doors must be closed and locked prior to remote start sequence.

01



Press unlock on OEM or aftermarket remote or request switch.

02



DO NOT PRESS BRAKE PEDAL. Push start button twice [2x] to ON position. Wait 2 seconds for key validation.

03



Press and release BRAKE pedal.

04



Take over procedure completed.

>>



Failure to follow procedure will result in vehicle engine shutdown.