



## HOW TO USE THIS INSTALL GUIDE

- 1** Open the Bookmarks menu and find your vehicle OR scroll down until you find the install guide for your vehicle.
- 2** Print only the pages for your vehicle using the advanced options in the Print menu.
- 3** Install your Maestro RR according to the guide for your vehicle.

## WARNING

Pressing the printer icon or “quick printing” this document will print all of the guides in this compilation.



# INSTALL GUIDE ACURA CSX WITH NAV 2006-2011

RETAINS STEERING WHEEL CONTROLS AND ADDS GAUGES



#### PRODUCTS REQUIRED

iDatalink Maestro RR Radio Replacement Interface  
iDatalink Compatible Radio

#### OPTIONAL ACCESSORIES

None

#### PROGRAMMED FIRMWARE

ADS-RR(SI)-HON01-DS

NOTICE: Automotive Data Solutions Inc. (ADS) recommends having this installation performed by a certified technician. Logos and trademarks used here in are the properties of their respective owners.

# WELCOME

Congratulations on the purchase of your iDatalink Maestro RR Radio replacement solution. You are now a few simple steps away from enjoying your new car radio with enhanced features.

Before starting your installation, please ensure that your iDatalink Maestro module is programmed with the correct firmware for your vehicle and that you carefully review the install guide.

**Please note that Maestro RR will only retain functionalities that were originally available in the vehicle.**

# NEED HELP?

 **1 866 427-2999**

 [support@idatalink.com](mailto:support@idatalink.com)

 [maestro.idatalink.com/support](http://maestro.idatalink.com/support)  
[www.12voltdata.com/forum](http://www.12voltdata.com/forum)

## TABLE OF CONTENTS

Wiring Diagram	<b>3</b>
Vehicle Wire Reference Chart	<b>4</b>

# WIRING DIAGRAM

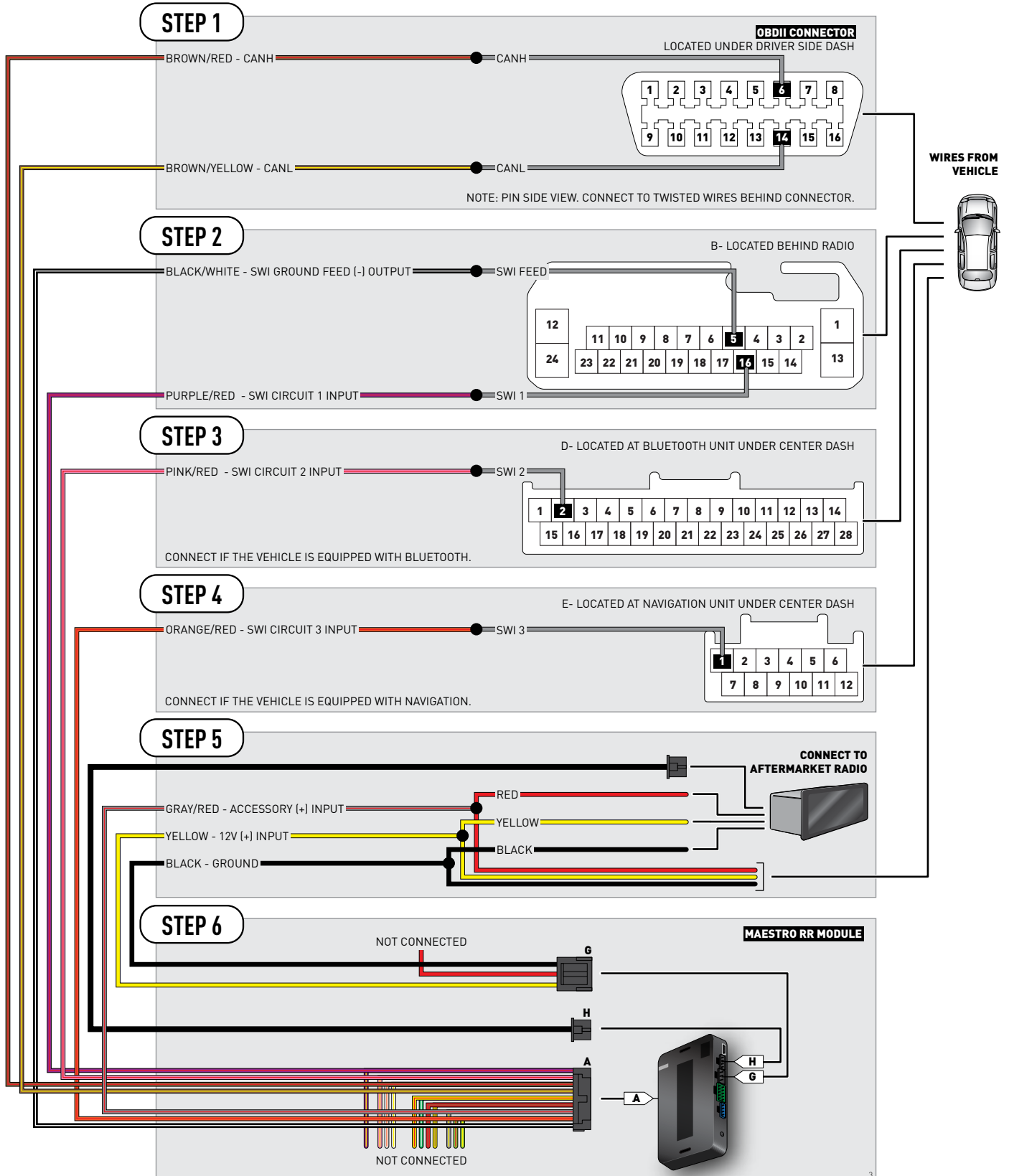

# VEHICLE WIRE REFERENCE CHART

Wire Description	Connector Name	Connector Color	Connector Type	Position	Wire Color	Polarity	Wire Location
CanH	A	~	16 pin	06	White	(DATA)	OBDII connector, under driver side dash
CanL	A	~	16 pin	14	Red	(DATA)	OBDII connector, under driver side dash
SWI 1	B	~	24 pin	16	Pink	(DATA)	Behind radio
SWI 2	D	~	28 pin	02	Blue	(DATA)	Bluetooth unit, under center dash
SWI 3	E	~	12 pin	01	Green	(DATA)	Nav unit, under center dash
SWI Feed	B	~	24 pin	05	Brown	(-)	Behind radio



# INSTALL GUIDE ACURA CSX WITHOUT NAV 2006-2011

RETAINS STEERING WHEEL CONTROLS AND ADDS GAUGES



#### PRODUCTS REQUIRED

iDatalink Maestro RR Radio Replacement Interface  
iDatalink Compatible Radio

#### OPTIONAL ACCESSORIES

None

#### PROGRAMMED FIRMWARE

ADS-RR(SI)-HON01-DS

NOTICE: Automotive Data Solutions Inc. (ADS) recommends having this installation performed by a certified technician. Logos and trademarks used here in are the properties of their respective owners.

# WELCOME

Congratulations on the purchase of your iDatalink Maestro RR Radio replacement solution. You are now a few simple steps away from enjoying your new car radio with enhanced features.

Before starting your installation, please ensure that your iDatalink Maestro module is programmed with the correct firmware for your vehicle and that you carefully review the install guide.

**Please note that Maestro RR will only retain functionalities that were originally available in the vehicle.**

# NEED HELP?

 **1 866 427-2999**

 [support@idatalink.com](mailto:support@idatalink.com)

 [maestro.idatalink.com/support](http://maestro.idatalink.com/support)  
[www.12voltdata.com/forum](http://www.12voltdata.com/forum)

## TABLE OF CONTENTS

Wiring Diagram	<b>3</b>
Vehicle Wire Reference Chart	<b>4</b>

# WIRING DIAGRAM

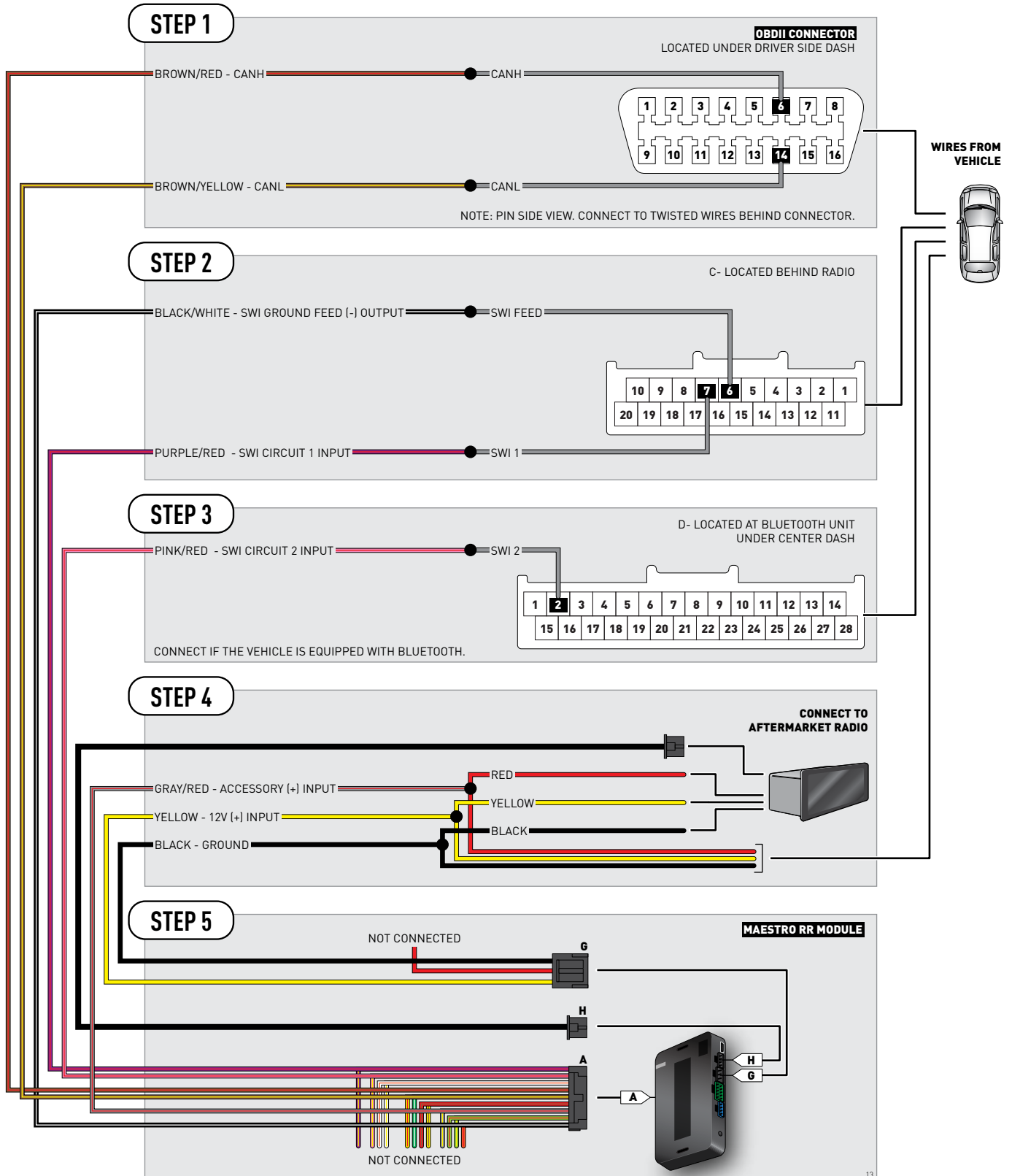



# VEHICLE WIRE REFERENCE CHART

Wire Description	Connector Name	Connector Color	Connector Type	Position	Wire Color	Polarity	Wire Location
CanH	A	~	16 pin	06	White	[DATA]	OBDII connector, under driver side dash
CanL	A	~	16 pin	14	Red	[DATA]	OBDII connector, under driver side dash
SWI 1	C	~	20 pin	07	Pink	[DATA]	Behind radio
SWI 2	D	~	28 pin	02	LtBlue	[DATA]	Bluetooth unit, under center dash
SWI Feed	C	~	20 pin	06	Brown	(-)	Behind radio



# INSTALL GUIDE ACURA ILX 2013-2015

RETAINS STEERING WHEEL CONTROLS AND ADDS GAUGES



#### PRODUCTS REQUIRED

iDatalink Maestro RR Radio Replacement Interface  
iDatalink Compatible Radio

#### OPTIONAL ACCESSORIES

None

#### PROGRAMMED FIRMWARE

ADS-RR(SI)-HON01-DS

NOTICE: Automotive Data Solutions Inc. (ADS) recommends having this installation performed by a certified technician. Logos and trademarks used here in are the properties of their respective owners.

# WELCOME

Congratulations on the purchase of your iDatalink Maestro RR Radio replacement solution. You are now a few simple steps away from enjoying your new car radio with enhanced features.

Before starting your installation, please ensure that your iDatalink Maestro module is programmed with the correct firmware for your vehicle and that you carefully review the install guide.

**Please note that Maestro RR will only retain functionalities that were originally available in the vehicle.**

# NEED HELP?

 **1 866 427-2999**

 [support@idatalink.com](mailto:support@idatalink.com)

 [maestro.idatalink.com/support](http://maestro.idatalink.com/support)  
[www.12voltdata.com/forum](http://www.12voltdata.com/forum)

## TABLE OF CONTENTS

Wiring Diagram	<b>3</b>
Vehicle Wire Reference Chart	<b>4</b>

# WIRING DIAGRAM

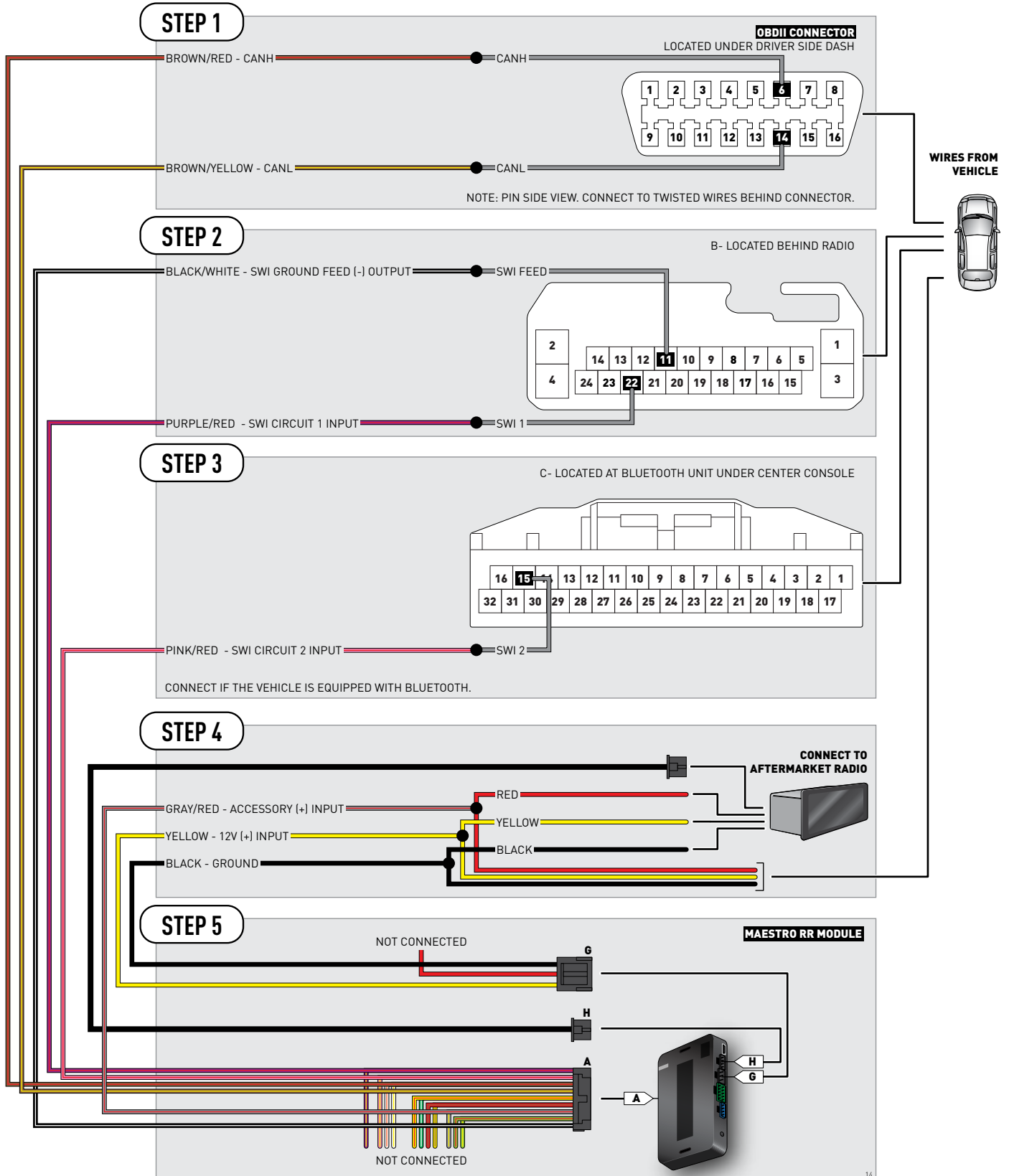

# VEHICLE WIRE REFERENCE CHART

Wire Description	Connector Name	Connector Color	Connector Type	Position	Wire Color	Polarity	Wire Location
CanH	A	~	16 pin	06	White	[DATA]	OBDII connector, under driver side dash
CanL	A	~	16 pin	14	Red	[DATA]	OBDII connector, under driver side dash
SWI 1	B	~	24 pin	22	Pink	[DATA]	Behind radio
SWI 2	C	~	32 pin	15	Blue	[DATA]	Bluetooth unit, under center console
SWI Feed	B	~	24 pin	11	Brown	(-)	Behind radio



# INSTALL GUIDE ACURA TSX 2009-2014

RETAINS STEERING WHEEL CONTROLS AND ADDS GAUGES



---

#### PRODUCTS REQUIRED

iDatalink Maestro RR Radio Replacement Interface  
iDatalink Compatible Radio

#### OPTIONAL ACCESSORIES

None

#### PROGRAMMED FIRMWARE

ADS-RR(SI)-HON01-DS

NOTICE: Automotive Data Solutions Inc. (ADS) recommends having this installation performed by a certified technician. Logos and trademarks used here in are the properties of their respective owners.

# WELCOME

Congratulations on the purchase of your iDatalink Maestro RR Radio replacement solution. You are now a few simple steps away from enjoying your new car radio with enhanced features.

Before starting your installation, please ensure that your iDatalink Maestro module is programmed with the correct firmware for your vehicle and that you carefully review the install guide.

**Please note that Maestro RR will only retain functionalities that were originally available in the vehicle.**

# NEED HELP?

 **1 866 427-2999**

 [support@idatalink.com](mailto:support@idatalink.com)

 [maestro.idatalink.com/support](http://maestro.idatalink.com/support)  
[www.12voltdata.com/forum](http://www.12voltdata.com/forum)

## TABLE OF CONTENTS

Wiring Diagram	<b>3</b>
Vehicle Wire Reference Chart	<b>4</b>

# WIRING DIAGRAM

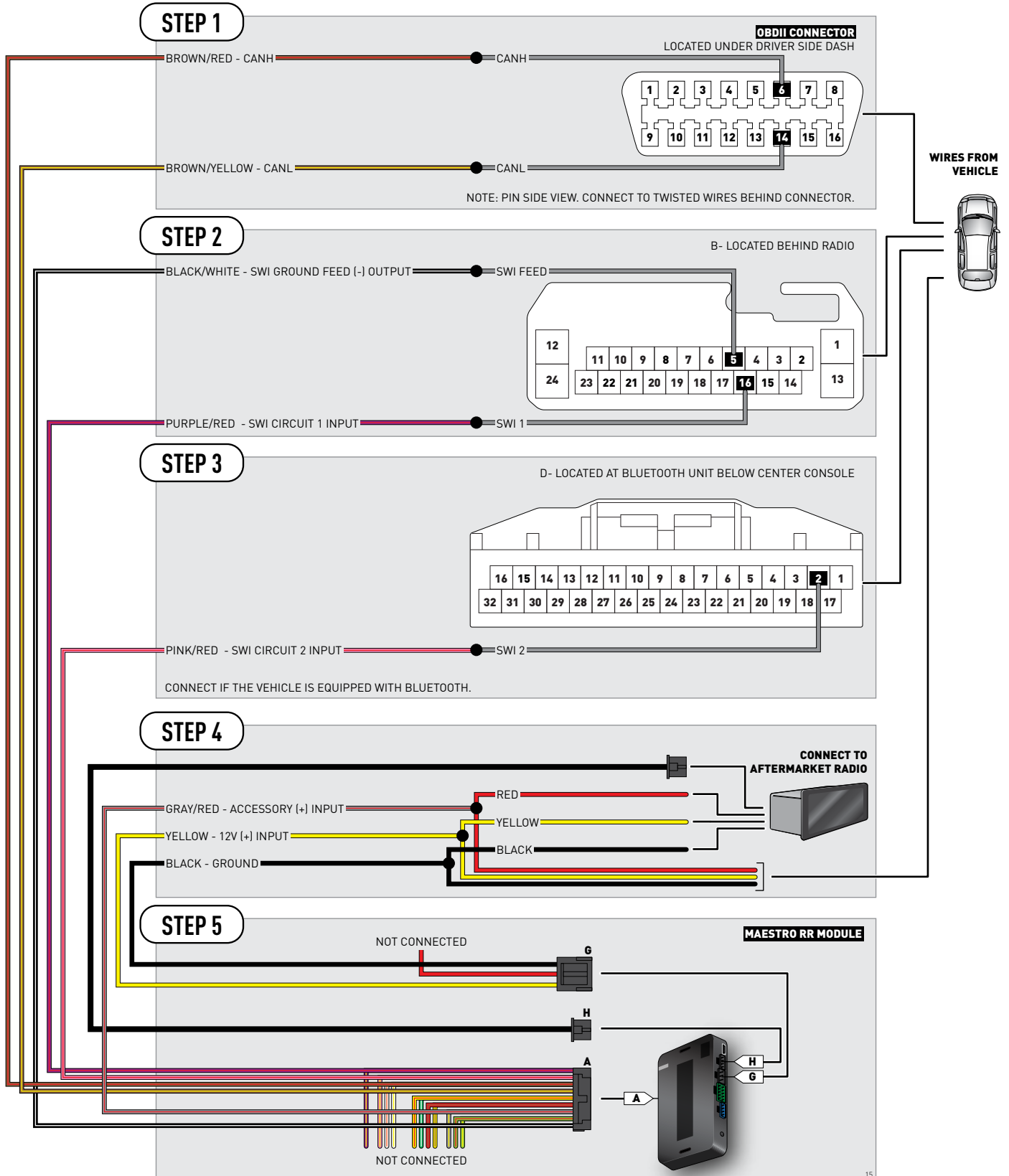



# VEHICLE WIRE REFERENCE CHART

Wire Description	Connector Name	Connector Color	Connector Type	Position	Wire Color	Polarity	Wire Location
CanH	A	~	16 pin	06	White	[DATA]	OBDII connector, under driver side dash
CanL	A	~	16 pin	14	Red	[DATA]	OBDII connector, under driver side dash
SWI 1	B	~	24 pin	16	Pink	[DATA]	Behind radio
SWI 2	C	~	32 pin	02	Purple	[DATA]	Bluetooth unit, under dash passenger side
SWI Feed	B	~	24 pin	05	Brown	(-)	Behind radio



# INSTALL GUIDE HONDA ACCORD 2008-2009

RETAINS STEERING WHEEL CONTROLS AND ADDS GAUGES



---

#### PRODUCTS REQUIRED

iDatalink Maestro RR Radio Replacement Interface  
iDatalink Compatible Radio

#### OPTIONAL ACCESSORIES

None

#### PROGRAMMED FIRMWARE

ADS-RR(SI)-HON01-DS

NOTICE: Automotive Data Solutions Inc. (ADS) recommends having this installation performed by a certified technician. Logos and trademarks used here in are the properties of their respective owners.

# WELCOME

Congratulations on the purchase of your iDatalink Maestro RR Radio replacement solution. You are now a few simple steps away from enjoying your new car radio with enhanced features.

Before starting your installation, please ensure that your iDatalink Maestro module is programmed with the correct firmware for your vehicle and that you carefully review the install guide.

**Please note that Maestro RR will only retain functionalities that were originally available in the vehicle.**

# NEED HELP?

 **1 866 427-2999**

 [support@idatalink.com](mailto:support@idatalink.com)

 [maestro.idatalink.com/support](http://maestro.idatalink.com/support)  
[www.12voltdata.com/forum](http://www.12voltdata.com/forum)

## TABLE OF CONTENTS

Wiring Diagram	<b>3</b>
Vehicle Wire Reference Chart	<b>4</b>

# WIRING DIAGRAM

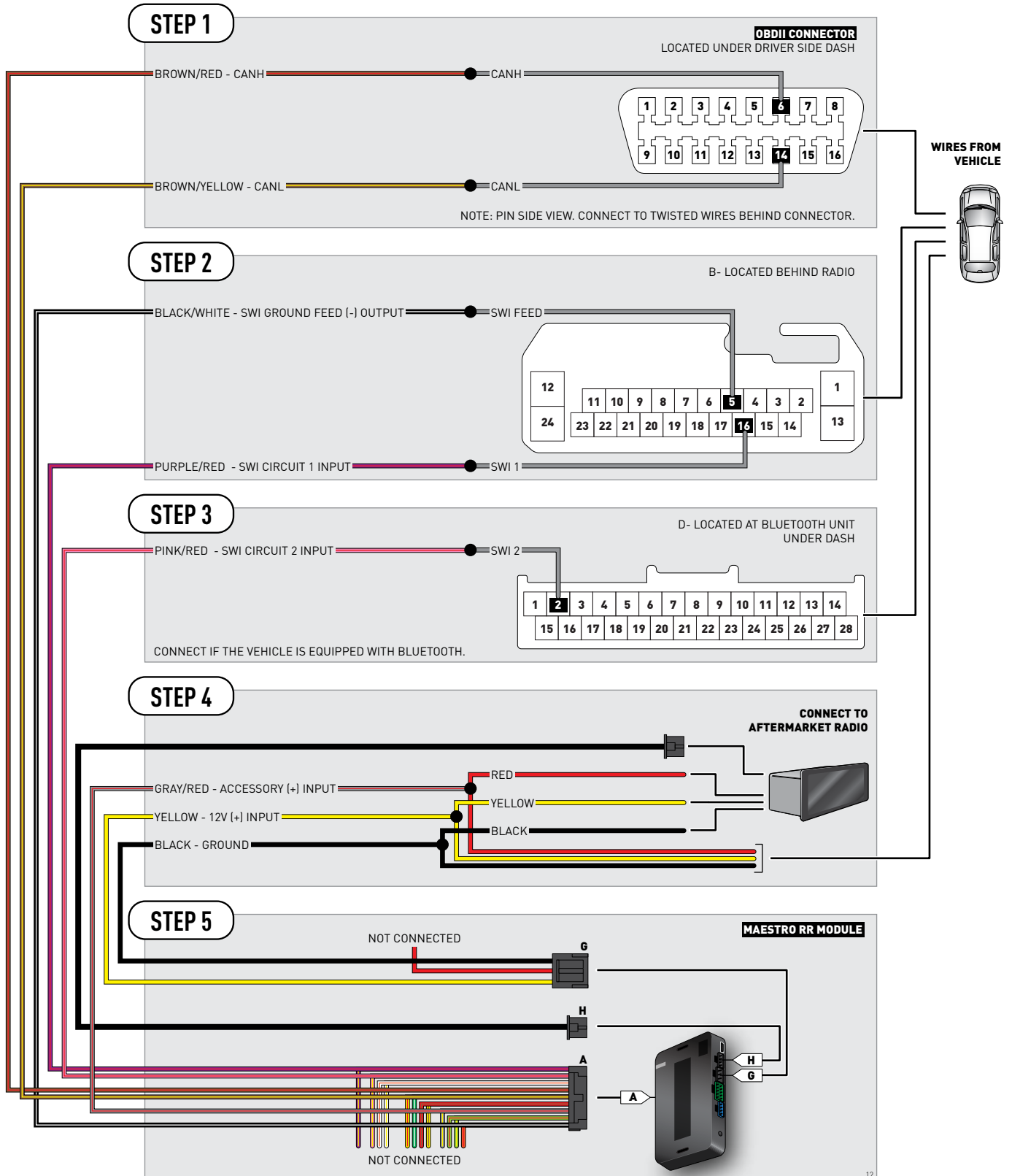

# VEHICLE WIRE REFERENCE CHART

Wire Description	Connector Name	Connector Color	Connector Type	Position	Wire Color	Polarity	Wire Location
CanH	A	~	16 pin	06	White	[DATA]	OBDII connector, under driver side dash
CanL	A	~	16 pin	14	Red	[DATA]	OBDII connector, under driver side dash
SWI 1	B	~	24 pin	16	Pink	[DATA]	Behind radio
SWI 2	D	~	28 pin	02	LtBlue	[DATA]	Bluetooth unit, under center dash
SWI Feed	B	~	24 pin	05	Brown	(-)	Behind radio



# INSTALL GUIDE HONDA ACCORD 2010-2012

RETAINS STEERING WHEEL CONTROLS AND ADDS GAUGES



#### PRODUCTS REQUIRED

iDatalink Maestro RR Radio Replacement Interface  
iDatalink Compatible Radio

#### OPTIONAL ACCESSORIES

None

#### PROGRAMMED FIRMWARE

ADS-RR(SI)-HON01-DS

NOTICE: Automotive Data Solutions Inc. (ADS) recommends having this installation performed by a certified technician. Logos and trademarks used here in are the properties of their respective owners.

# WELCOME

Congratulations on the purchase of your iDatalink Maestro RR Radio replacement solution. You are now a few simple steps away from enjoying your new car radio with enhanced features.

Before starting your installation, please ensure that your iDatalink Maestro module is programmed with the correct firmware for your vehicle and that you carefully review the install guide.

**Please note that Maestro RR will only retain functionalities that were originally available in the vehicle.**

# NEED HELP?

 **1 866 427-2999**

 [support@idatalink.com](mailto:support@idatalink.com)

 [maestro.idatalink.com/support](http://maestro.idatalink.com/support)  
[www.12voltdata.com/forum](http://www.12voltdata.com/forum)

## TABLE OF CONTENTS

Wiring Diagram	<b>3</b>
Vehicle Wire Reference Chart	<b>4</b>

# WIRING DIAGRAM

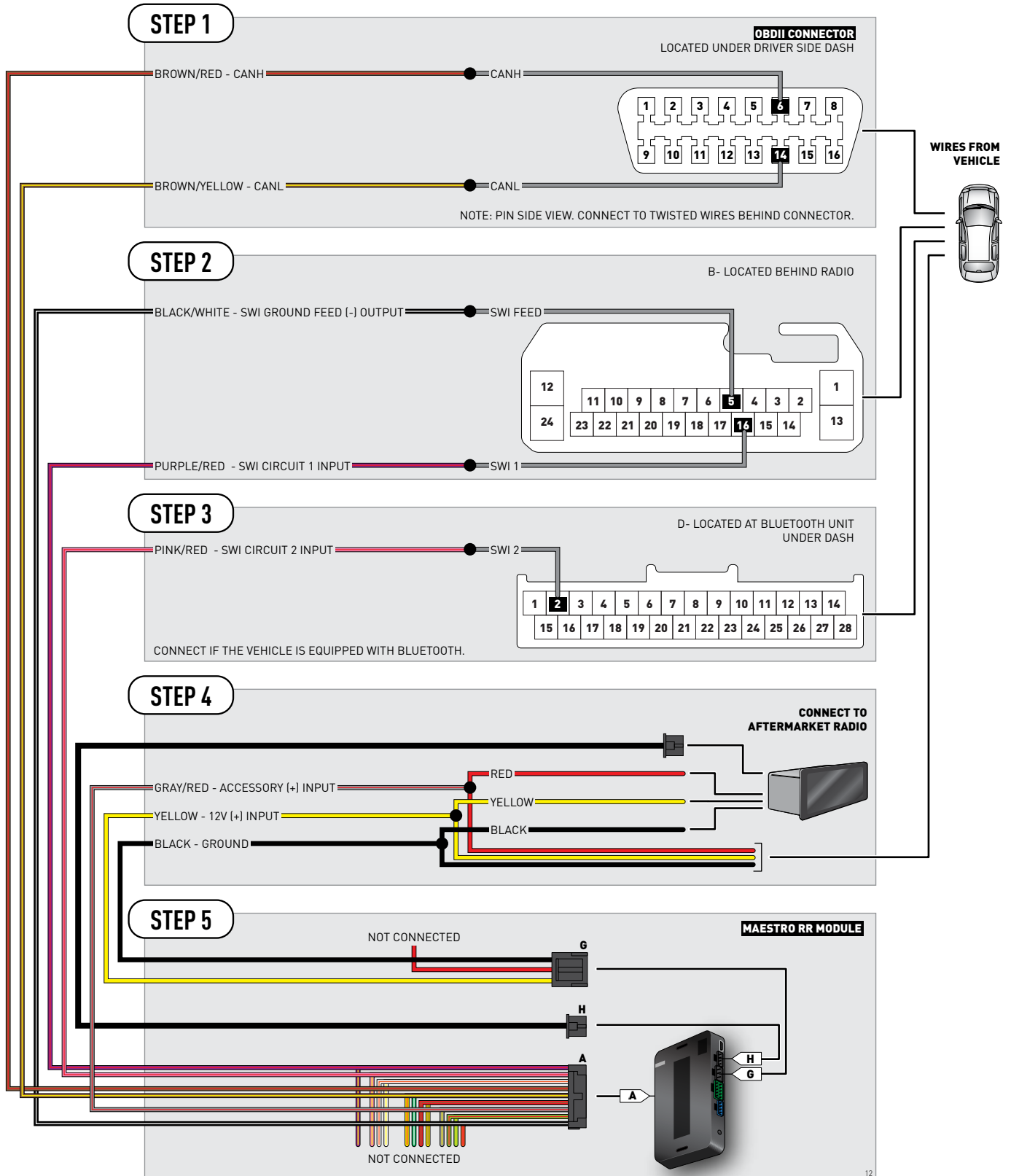



# VEHICLE WIRE REFERENCE CHART

Wire Description	Connector Name	Connector Color	Connector Type	Position	Wire Color	Polarity	Wire Location
CanH	A	~	16 pin	06	White	[DATA]	OBDII connector, under driver side dash
CanL	A	~	16 pin	14	Red	[DATA]	OBDII connector, under driver side dash
SWI 1	B	~	24 pin	16	Pink	[DATA]	Behind radio
SWI 2	D	~	28 pin	02	LtBlue	[DATA]	Bluetooth unit, under driver side dash
SWI Feed	B	~	24 pin	05	Brown	(-)	Behind radio



# INSTALL GUIDE HONDA ACCORD 2013-2016

RETAINS STEERING WHEEL CONTROLS AND ADDS GAUGES



#### PRODUCTS REQUIRED

iDatalink Maestro RR Radio Replacement Interface  
iDatalink Compatible Radio

#### OPTIONAL ACCESSORIES

None

#### PROGRAMMED FIRMWARE

ADS-RR(SI)-HON01-DS

NOTICE: Automotive Data Solutions Inc. (ADS) recommends having this installation performed by a certified technician. Logos and trademarks used here in are the properties of their respective owners.

# WELCOME

Congratulations on the purchase of your iDatalink Maestro RR Radio replacement solution. You are now a few simple steps away from enjoying your new car radio with enhanced features.

Before starting your installation, please ensure that your iDatalink Maestro module is programmed with the correct firmware for your vehicle and that you carefully review the install guide.

**Please note that Maestro RR will only retain functionalities that were originally available in the vehicle.**

# NEED HELP?

 **1 866 427-2999**

 [support@idatalink.com](mailto:support@idatalink.com)

 [maestro.idatalink.com/support](http://maestro.idatalink.com/support)  
[www.12voltdata.com/forum](http://www.12voltdata.com/forum)

## TABLE OF CONTENTS

Wiring Diagram	<b>3</b>
Vehicle Wire Reference Chart	<b>4</b>

# WIRING DIAGRAM

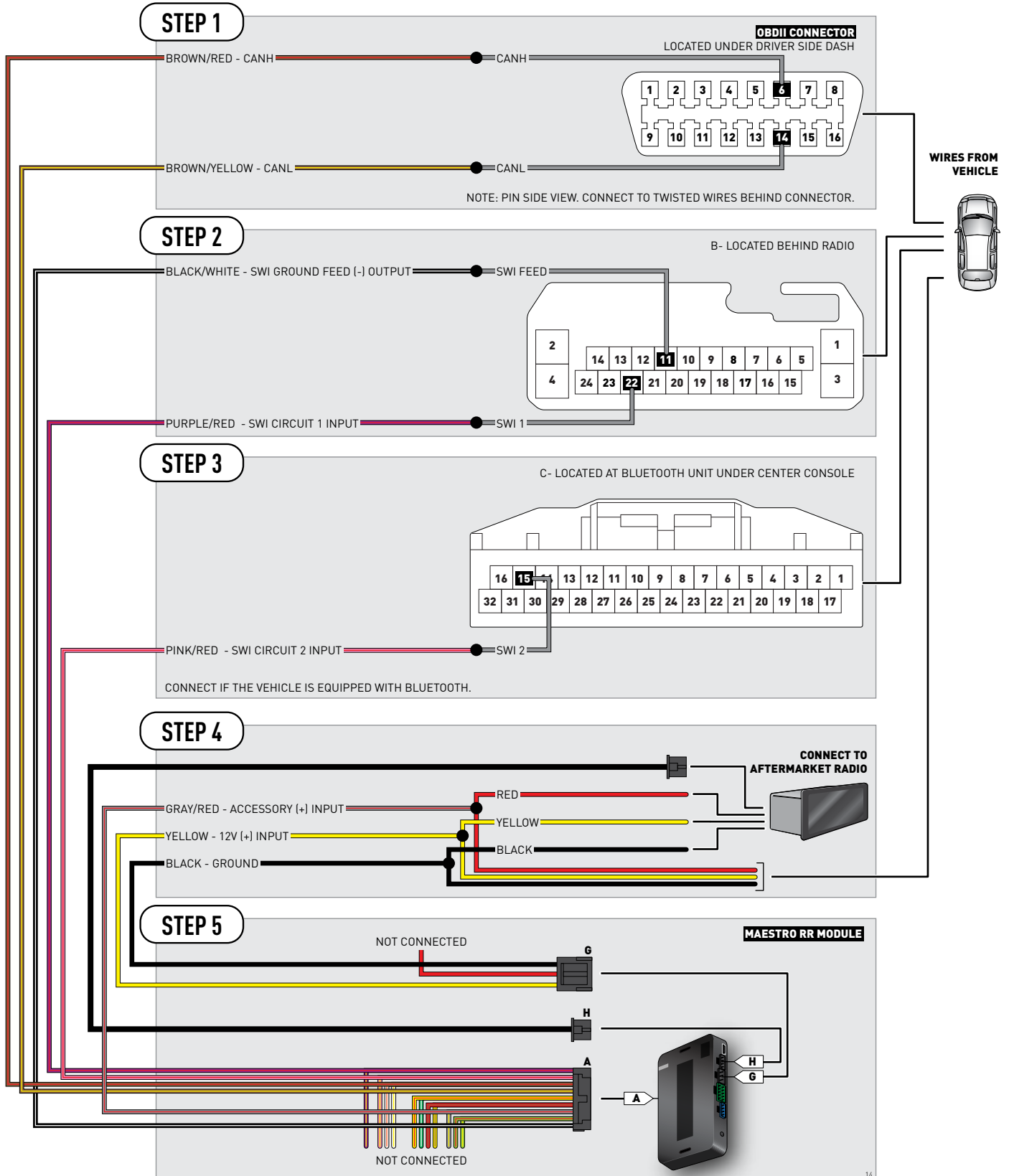

# VEHICLE WIRE REFERENCE CHART

Wire Description	Connector Name	Connector Color	Connector Type	Position	Wire Color	Polarity	Wire Location
CanH	A	~	16 pin	06	White	[DATA]	OBDII connector, under driver side dash
CanL	A	~	16 pin	14	Red	[DATA]	OBDII connector, under driver side dash
SWI 1	B	~	24 pin	22	Pink	[DATA]	Behind radio
SWI 2	C	~	32 pin	15	Blue	[DATA]	Bluetooth unit, under center console
SWI Feed	B	~	24 pin	11	Brown	(-)	Behind radio



# INSTALL GUIDE HONDA ACCORD CROSSTOUR 2010-2012

RETAINS STEERING WHEEL CONTROLS AND ADDS GAUGES



#### PRODUCTS REQUIRED

iDatalink Maestro RR Radio Replacement Interface  
iDatalink Compatible Radio

#### OPTIONAL ACCESSORIES

None

#### PROGRAMMED FIRMWARE

ADS-RR(SI)-HON01-DS

NOTICE: Automotive Data Solutions Inc. (ADS) recommends having this installation performed by a certified technician. Logos and trademarks used here in are the properties of their respective owners.

# WELCOME

Congratulations on the purchase of your iDatalink Maestro RR Radio replacement solution. You are now a few simple steps away from enjoying your new car radio with enhanced features.

Before starting your installation, please ensure that your iDatalink Maestro module is programmed with the correct firmware for your vehicle and that you carefully review the install guide.

**Please note that Maestro RR will only retain functionalities that were originally available in the vehicle.**

# NEED HELP?

 **1 866 427-2999**

 [support@idatalink.com](mailto:support@idatalink.com)

 [maestro.idatalink.com/support](http://maestro.idatalink.com/support)  
[www.12voltdata.com/forum](http://www.12voltdata.com/forum)

## TABLE OF CONTENTS

Wiring Diagram	<b>3</b>
Vehicle Wire Reference Chart	<b>4</b>

# WIRING DIAGRAM

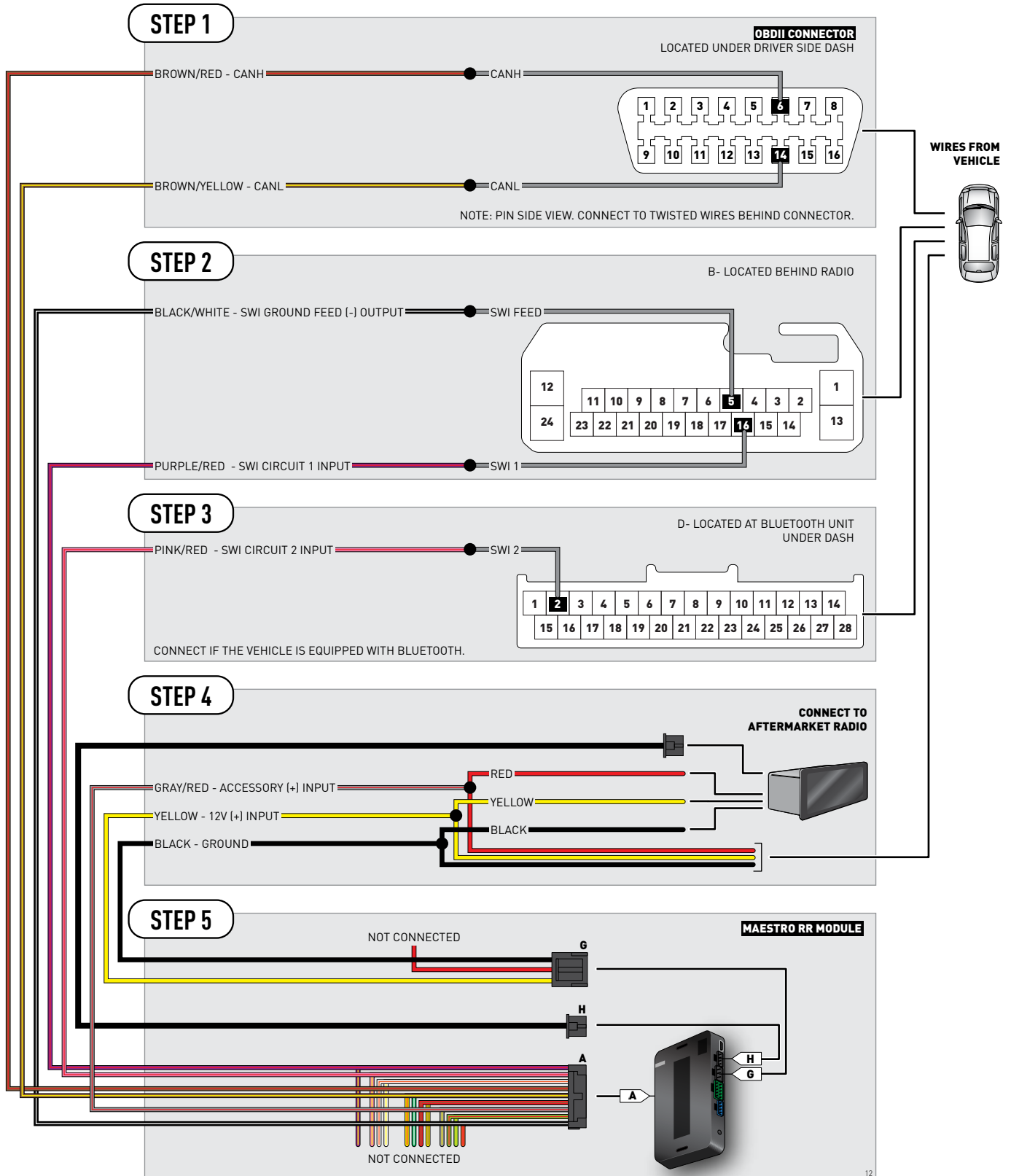

12



# VEHICLE WIRE REFERENCE CHART

Wire Description	Connector Name	Connector Color	Connector Type	Position	Wire Color	Polarity	Wire Location
CanH	A	~	16 pin	06	White	[DATA]	OBDII connector, under driver side dash
CanL	A	~	16 pin	14	Red	[DATA]	OBDII connector, under driver side dash
SWI 1	B	~	24 pin	16	Pink	[DATA]	Behind radio
SWI 2	D	~	28 pin	02	LtBlue	[DATA]	Bluetooth unit, under driver side dash
SWI Feed	B	~	24 pin	05	Brown	(-)	Behind radio



# INSTALL GUIDE

# HONDA ACCORD CROSSTOUR

# 2013-2016

RETAINS STEERING WHEEL CONTROLS AND ADDS GAUGES



#### PRODUCTS REQUIRED

iDatalink Maestro RR Radio Replacement Interface  
iDatalink Compatible Radio

#### OPTIONAL ACCESSORIES

None

#### PROGRAMMED FIRMWARE

ADS-RR(SI)-HON01-DS

NOTICE: Automotive Data Solutions Inc. (ADS) recommends having this installation performed by a certified technician. Logos and trademarks used here in are the properties of their respective owners.

# WELCOME

Congratulations on the purchase of your iDatalink Maestro RR Radio replacement solution. You are now a few simple steps away from enjoying your new car radio with enhanced features.

Before starting your installation, please ensure that your iDatalink Maestro module is programmed with the correct firmware for your vehicle and that you carefully review the install guide.

**Please note that Maestro RR will only retain functionalities that were originally available in the vehicle.**

# NEED HELP?

 **1 866 427-2999**

 **[support@idatalink.com](mailto:support@idatalink.com)**

 **[maestro.idatalink.com/support](http://maestro.idatalink.com/support)  
[www.12voltdata.com/forum](http://www.12voltdata.com/forum)**

## TABLE OF CONTENTS

Wiring Diagram	<b>3</b>
Vehicle Wire Reference Chart	<b>4</b>

# WIRING DIAGRAM

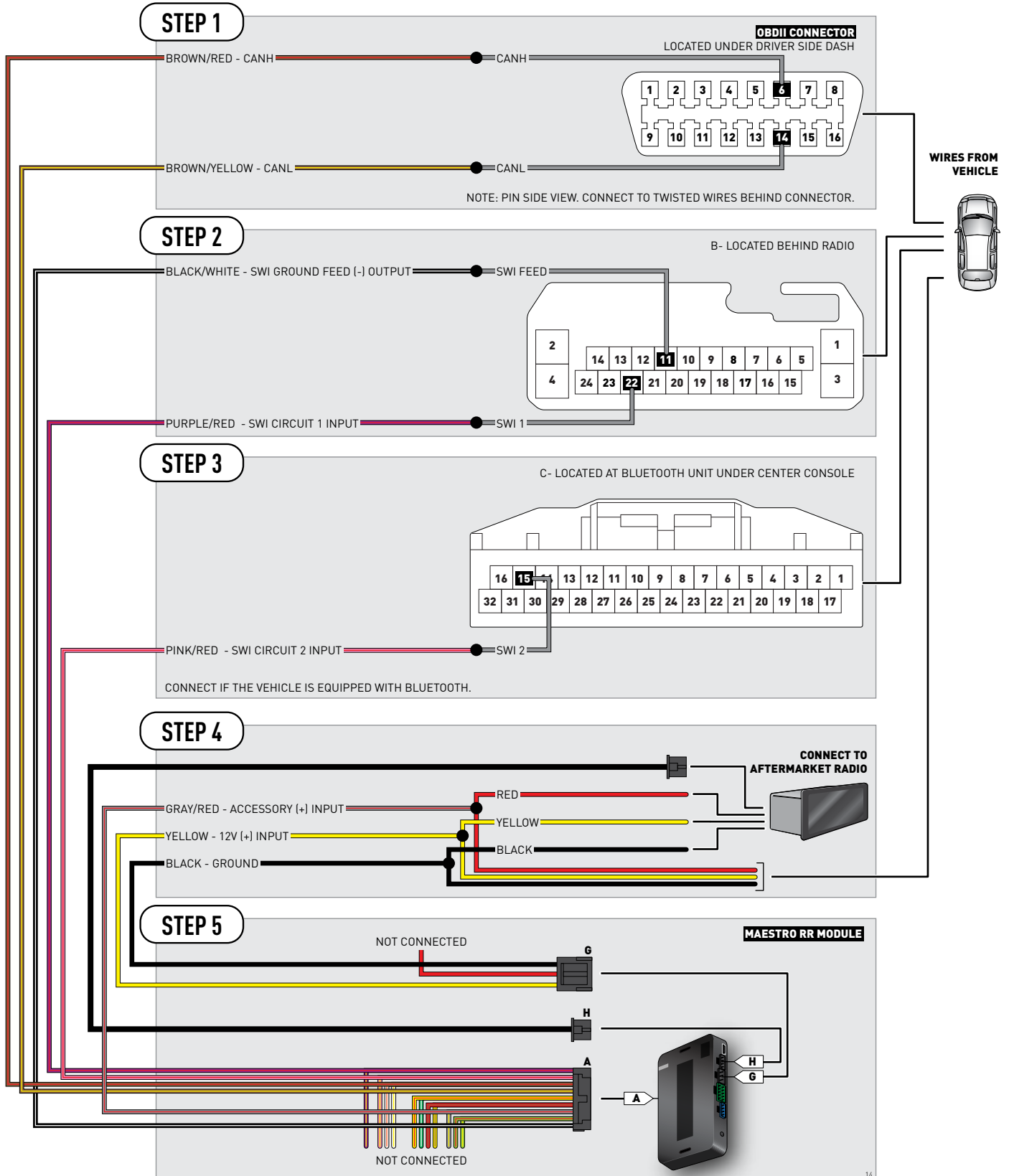

# VEHICLE WIRE REFERENCE CHART

Wire Description	Connector Name	Connector Color	Connector Type	Position	Wire Color	Polarity	Wire Location
CanH	A	~	16 pin	06	White	[DATA]	OBDII connector, under driver side dash
CanL	A	~	16 pin	14	Red	[DATA]	OBDII connector, under driver side dash
SWI 1	B	~	24 pin	22	Pink	[DATA]	Behind radio
SWI 2	C	~	32 pin	15	Blue	[DATA]	Bluetooth unit, under center console
SWI Feed	B	~	24 pin	11	Brown	(-)	Behind radio



# INSTALL GUIDE HONDA CIVIC WITH NAV 2006-2011

RETAINS STEERING WHEEL CONTROLS AND ADDS GAUGES



#### PRODUCTS REQUIRED

iDatalink Maestro RR Radio Replacement Interface  
iDatalink Compatible Radio

#### OPTIONAL ACCESSORIES

None

#### PROGRAMMED FIRMWARE

ADS-RR(SI)-HON01-DS

NOTICE: Automotive Data Solutions Inc. (ADS) recommends having this installation performed by a certified technician. Logos and trademarks used here in are the properties of their respective owners.

# WELCOME

Congratulations on the purchase of your iDatalink Maestro RR Radio replacement solution. You are now a few simple steps away from enjoying your new car radio with enhanced features.

Before starting your installation, please ensure that your iDatalink Maestro module is programmed with the correct firmware for your vehicle and that you carefully review the install guide.

**Please note that Maestro RR will only retain functionalities that were originally available in the vehicle.**

# NEED HELP?

 **1 866 427-2999**

 [support@idatalink.com](mailto:support@idatalink.com)

 [maestro.idatalink.com/support](http://maestro.idatalink.com/support)  
[www.12voltdata.com/forum](http://www.12voltdata.com/forum)

## TABLE OF CONTENTS

Wiring Diagram	<b>3</b>
Vehicle Wire Reference Chart	<b>4</b>

# WIRING DIAGRAM

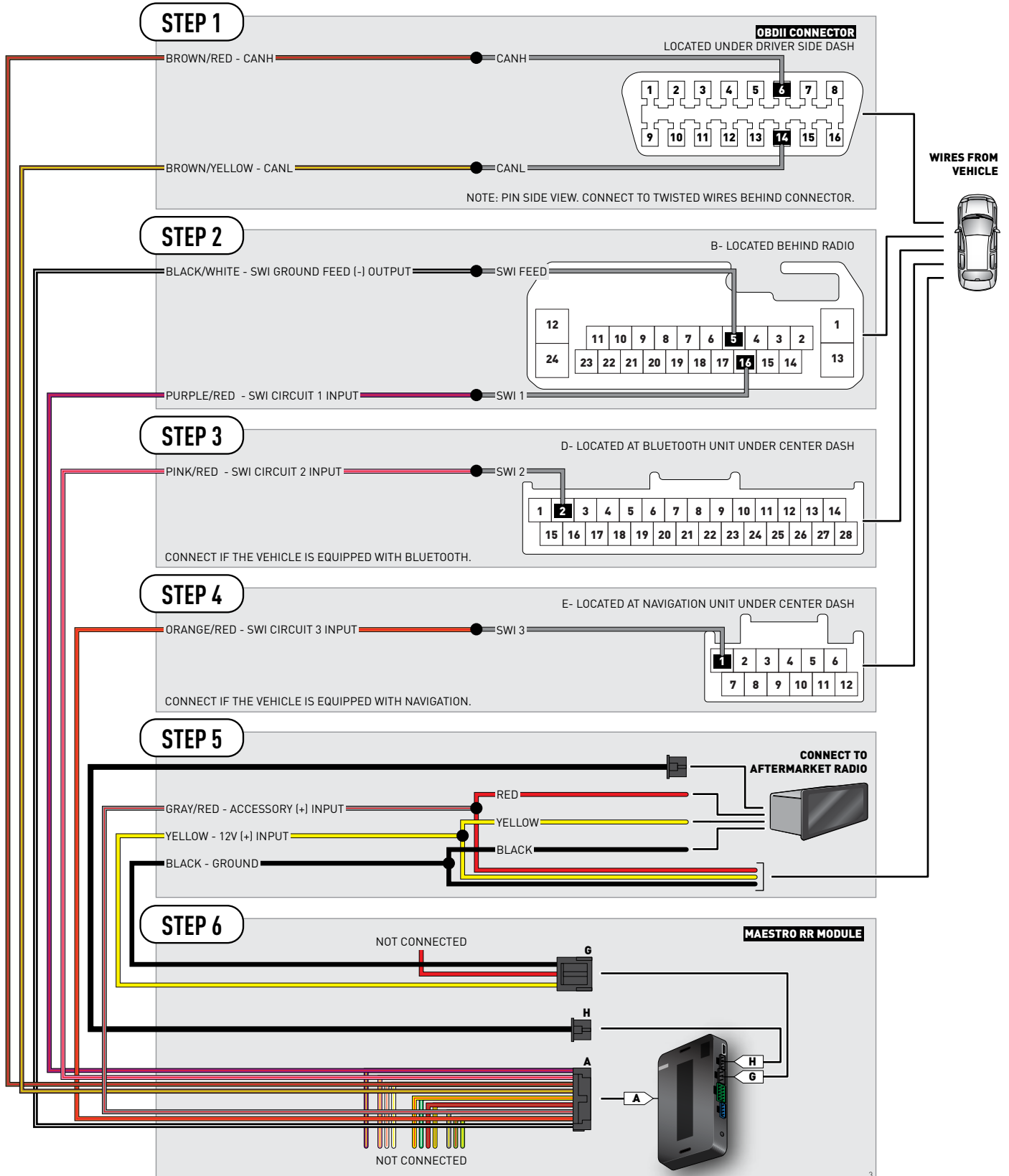



# VEHICLE WIRE REFERENCE CHART

Wire Description	Connector Name	Connector Color	Connector Type	Position	Wire Color	Polarity	Wire Location
CanH	A	~	16 pin	06	White	(DATA)	OBDII connector, under driver side dash
CanL	A	~	16 pin	14	Red	(DATA)	OBDII connector, under driver side dash
SWI 1	B	~	24 pin	16	Pink	(DATA)	Behind radio
SWI 2	D	~	28 pin	02	Blue	(DATA)	Bluetooth unit, under center dash
SWI 3	E	~	12 pin	01	Green	(DATA)	Nav unit, under center dash
SWI Feed	B	~	24 pin	05	Brown	(-)	Behind radio



# INSTALL GUIDE HONDA CIVIC WITH NAV 2012-2015

RETAINS STEERING WHEEL CONTROLS AND ADDS GAUGES



#### PRODUCTS REQUIRED

iDatalink Maestro RR Radio Replacement Interface  
iDatalink Compatible Radio

#### OPTIONAL ACCESSORIES

None

#### PROGRAMMED FIRMWARE

ADS-RR(SI)-HON01-DS

NOTICE: Automotive Data Solutions Inc. (ADS) recommends having this installation performed by a certified technician. Logos and trademarks used here in are the properties of their respective owners.

# WELCOME

Congratulations on the purchase of your iDatalink Maestro RR Radio replacement solution. You are now a few simple steps away from enjoying your new car radio with enhanced features.

Before starting your installation, please ensure that your iDatalink Maestro module is programmed with the correct firmware for your vehicle and that you carefully review the install guide.

**Please note that Maestro RR will only retain functionalities that were originally available in the vehicle.**

# NEED HELP?

 **1 866 427-2999**

 [support@idatalink.com](mailto:support@idatalink.com)

 [maestro.idatalink.com/support](http://maestro.idatalink.com/support)  
[www.12voltdata.com/forum](http://www.12voltdata.com/forum)

## TABLE OF CONTENTS

Wiring Diagram	<b>3</b>
Vehicle Wire Reference Chart	<b>4</b>

# WIRING DIAGRAM

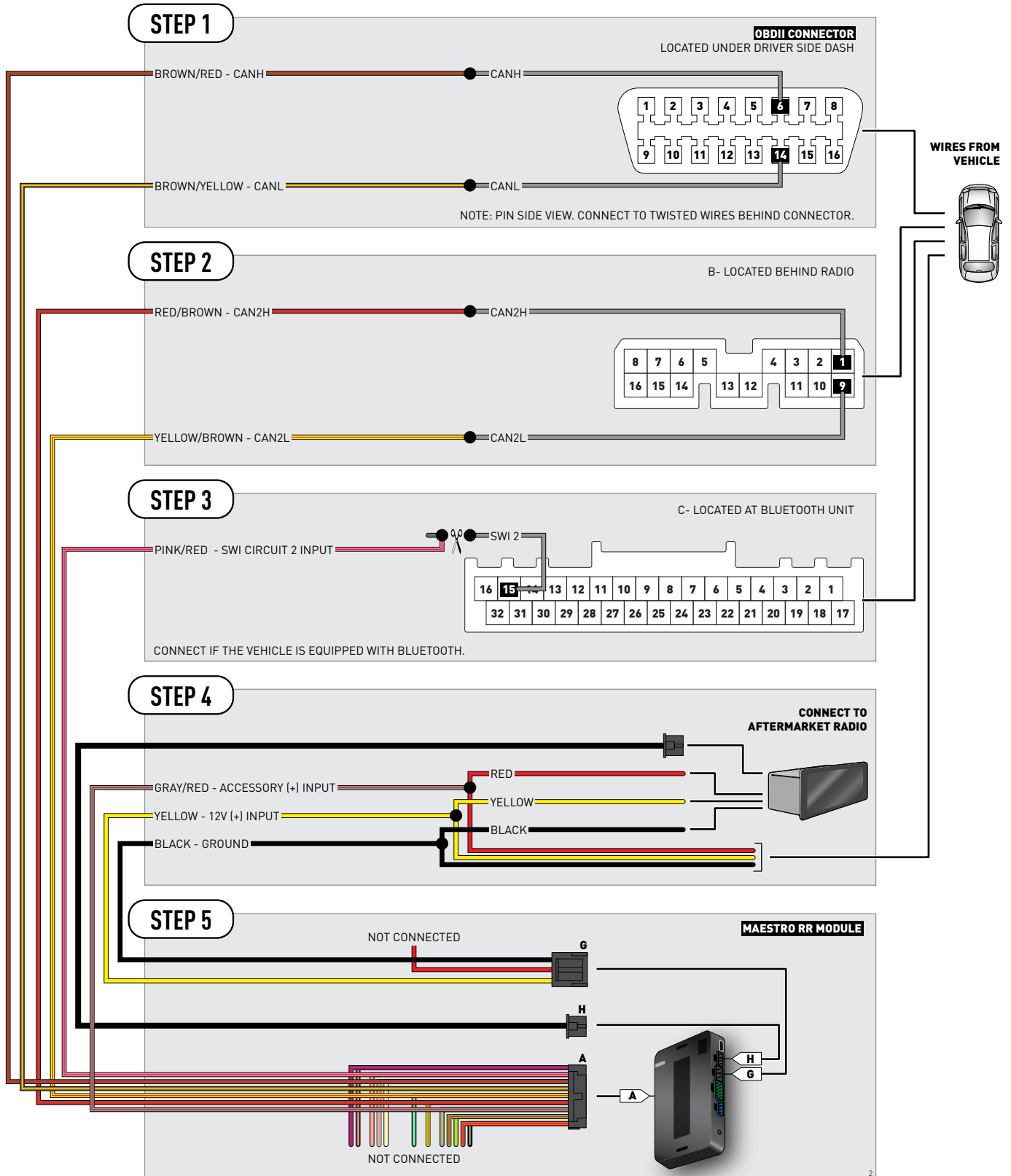

# VEHICLE WIRE REFERENCE CHART

Wire Description	Connector Name	Connector Color	Connector Type	Position	Wire Color	Polarity	Wire Location
CanH	A	~	16 pin	06	White	(DATA)	OBDII connector, under driver side dash
CanL	A	~	16 pin	14	Red	(DATA)	OBDII connector, under driver side dash
Can2H	B	~	20 pin	01	Pink	(DATA)	Behind radio
Can2L	B	~	20 pin	09	Blue	(DATA)	Behind radio
SWI 2	C	~	32 pin	15	Blue	(DATA)	Bluetooth unit, above glove box



# INSTALL GUIDE HONDA CIVIC WITHOUT NAV 2006-2011

RETAINS STEERING WHEEL CONTROLS AND ADDS GAUGES



#### PRODUCTS REQUIRED

iDatalink Maestro RR Radio Replacement Interface  
iDatalink Compatible Radio

#### OPTIONAL ACCESSORIES

None

#### PROGRAMMED FIRMWARE

ADS-RR(SI)-HON01-DS

NOTICE: Automotive Data Solutions Inc. (ADS) recommends having this installation performed by a certified technician. Logos and trademarks used here in are the properties of their respective owners.

# WELCOME

Congratulations on the purchase of your iDatalink Maestro RR Radio replacement solution. You are now a few simple steps away from enjoying your new car radio with enhanced features.

Before starting your installation, please ensure that your iDatalink Maestro module is programmed with the correct firmware for your vehicle and that you carefully review the install guide.

**Please note that Maestro RR will only retain functionalities that were originally available in the vehicle.**

# NEED HELP?

 **1 866 427-2999**

 [support@idatalink.com](mailto:support@idatalink.com)

 [maestro.idatalink.com/support](http://maestro.idatalink.com/support)  
[www.12voltdata.com/forum](http://www.12voltdata.com/forum)

## TABLE OF CONTENTS

Wiring Diagram	<b>3</b>
Vehicle Wire Reference Chart	<b>4</b>

# WIRING DIAGRAM

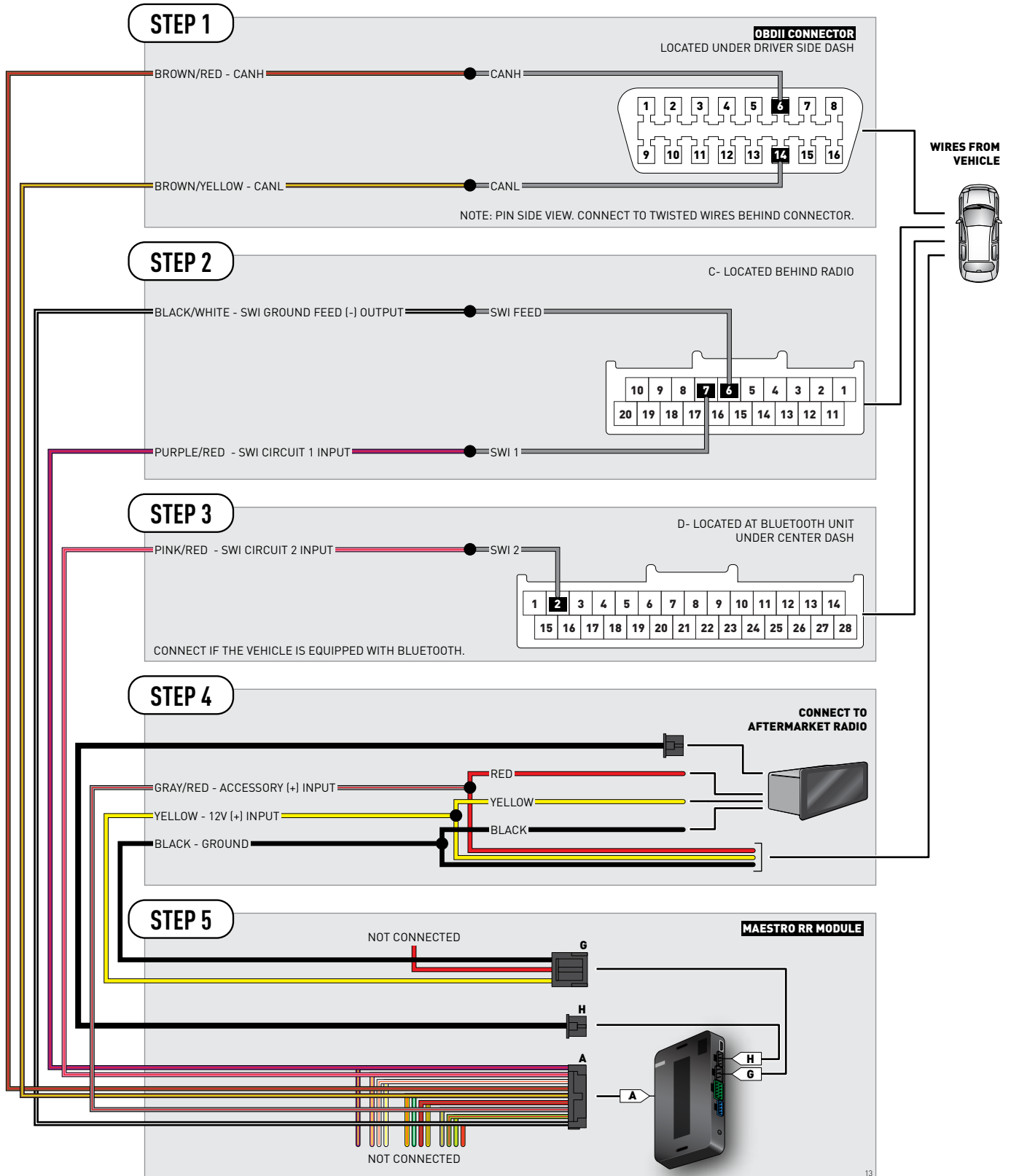



# VEHICLE WIRE REFERENCE CHART

Wire Description	Connector Name	Connector Color	Connector Type	Position	Wire Color	Polarity	Wire Location
CanH	A	~	16 pin	06	White	[DATA]	OBDII connector, under driver side dash
CanL	A	~	16 pin	14	Red	[DATA]	OBDII connector, under driver side dash
SWI 1	C	~	20 pin	07	Pink	[DATA]	Behind radio
SWI 2	D	~	28 pin	02	LtBlue	[DATA]	Bluetooth unit, under center dash
SWI Feed	C	~	20 pin	06	Brown	(-)	Behind radio



# INSTALL GUIDE HONDA CIVIC WITHOUT NAV 2012-2015

RETAINS STEERING WHEEL CONTROLS AND ADDS GAUGES



#### PRODUCTS REQUIRED

iDatalink Maestro RR Radio Replacement Interface  
iDatalink Compatible Radio

#### OPTIONAL ACCESSORIES

None

#### PROGRAMMED FIRMWARE

ADS-RR(SI)-HON01-DS

NOTICE: Automotive Data Solutions Inc. (ADS) recommends having this installation performed by a certified technician. Logos and trademarks used here in are the properties of their respective owners.

# WELCOME

Congratulations on the purchase of your iDatalink Maestro RR Radio replacement solution. You are now a few simple steps away from enjoying your new car radio with enhanced features.

Before starting your installation, please ensure that your iDatalink Maestro module is programmed with the correct firmware for your vehicle and that you carefully review the install guide.

**Please note that Maestro RR will only retain functionalities that were originally available in the vehicle.**

# NEED HELP?

 **1 866 427-2999**

 [support@idatalink.com](mailto:support@idatalink.com)

 [maestro.idatalink.com/support](http://maestro.idatalink.com/support)  
[www.12voltdata.com/forum](http://www.12voltdata.com/forum)

## TABLE OF CONTENTS

Wiring Diagram	<b>3</b>
Vehicle Wire Reference Chart	<b>4</b>

# WIRING DIAGRAM

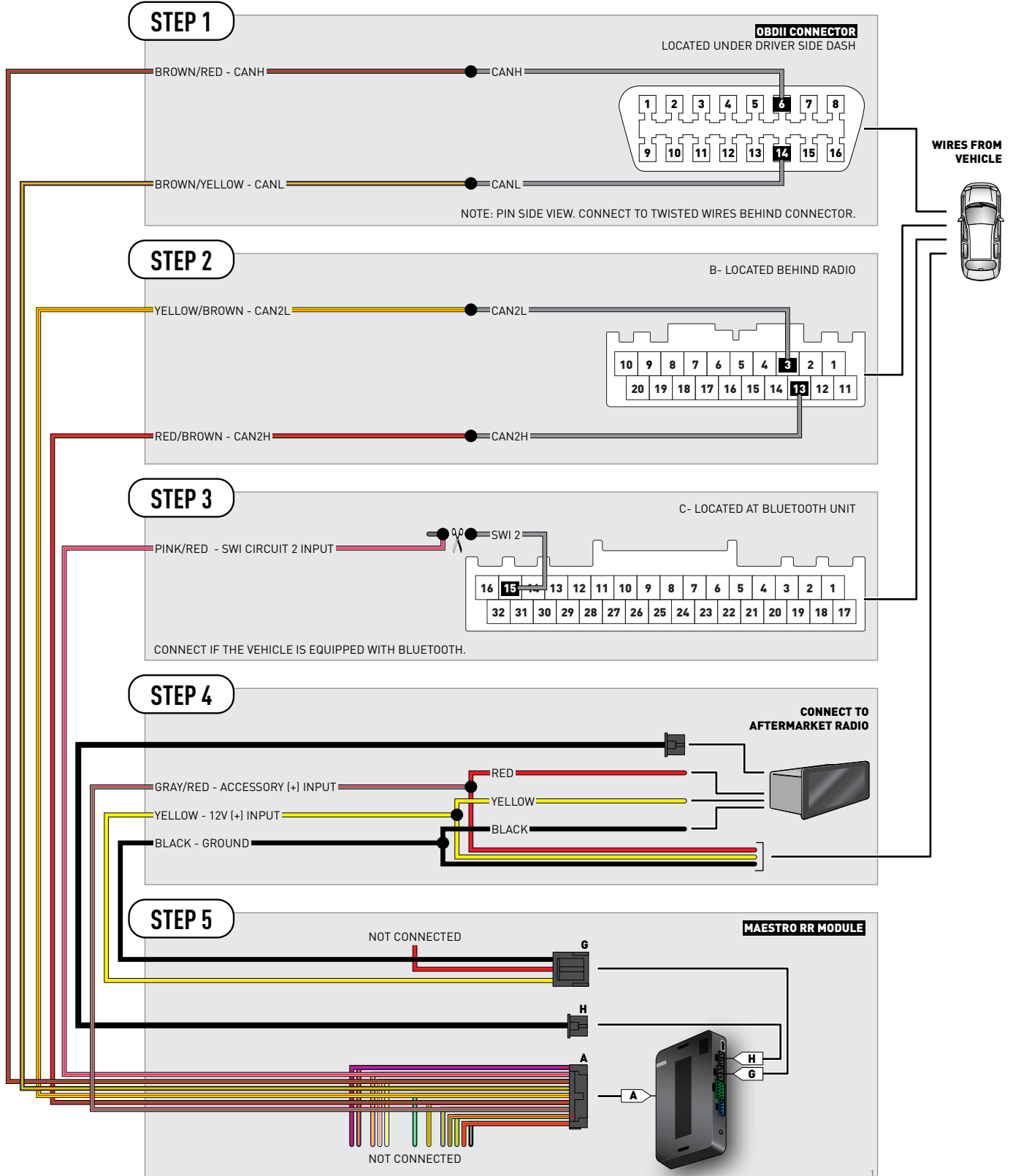

# VEHICLE WIRE REFERENCE CHART

Wire Description	Connector Name	Connector Color	Connector Type	Position	Wire Color	Polarity	Wire Location
CanH	A	~	16 pin	06	White	(DATA)	OBDII connector, under driver side dash
CanL	A	~	16 pin	14	Red	(DATA)	OBDII connector, under driver side dash
Can2H	B	~	20 pin	13	Pink	(DATA)	Behind radio
Can2L	B	~	20 pin	03	Blue	(DATA)	Behind radio
SWI 2	C	~	32 pin	15	Blue	(DATA)	Bluetooth unit, above glove box



# INSTALL GUIDE HONDA CRV WITH NAV 2007-2012

RETAINS STEERING WHEEL CONTROLS AND ADDS GAUGES



#### PRODUCTS REQUIRED

iDatalink Maestro RR Radio Replacement Interface  
iDatalink Compatible Radio

#### OPTIONAL ACCESSORIES

None

#### PROGRAMMED FIRMWARE

ADS-RR(SI)-HON01-DS

NOTICE: Automotive Data Solutions Inc. (ADS) recommends having this installation performed by a certified technician. Logos and trademarks used here in are the properties of their respective owners.

# WELCOME

Congratulations on the purchase of your iDatalink Maestro RR Radio replacement solution. You are now a few simple steps away from enjoying your new car radio with enhanced features.

Before starting your installation, please ensure that your iDatalink Maestro module is programmed with the correct firmware for your vehicle and that you carefully review the install guide.

**Please note that Maestro RR will only retain functionalities that were originally available in the vehicle.**

# NEED HELP?

 **1 866 427-2999**

 [support@idatalink.com](mailto:support@idatalink.com)

 [maestro.idatalink.com/support](http://maestro.idatalink.com/support)  
[www.12voltdata.com/forum](http://www.12voltdata.com/forum)

## TABLE OF CONTENTS

Wiring Diagram	<b>3</b>
Vehicle Wire Reference Chart	<b>4</b>

# WIRING DIAGRAM

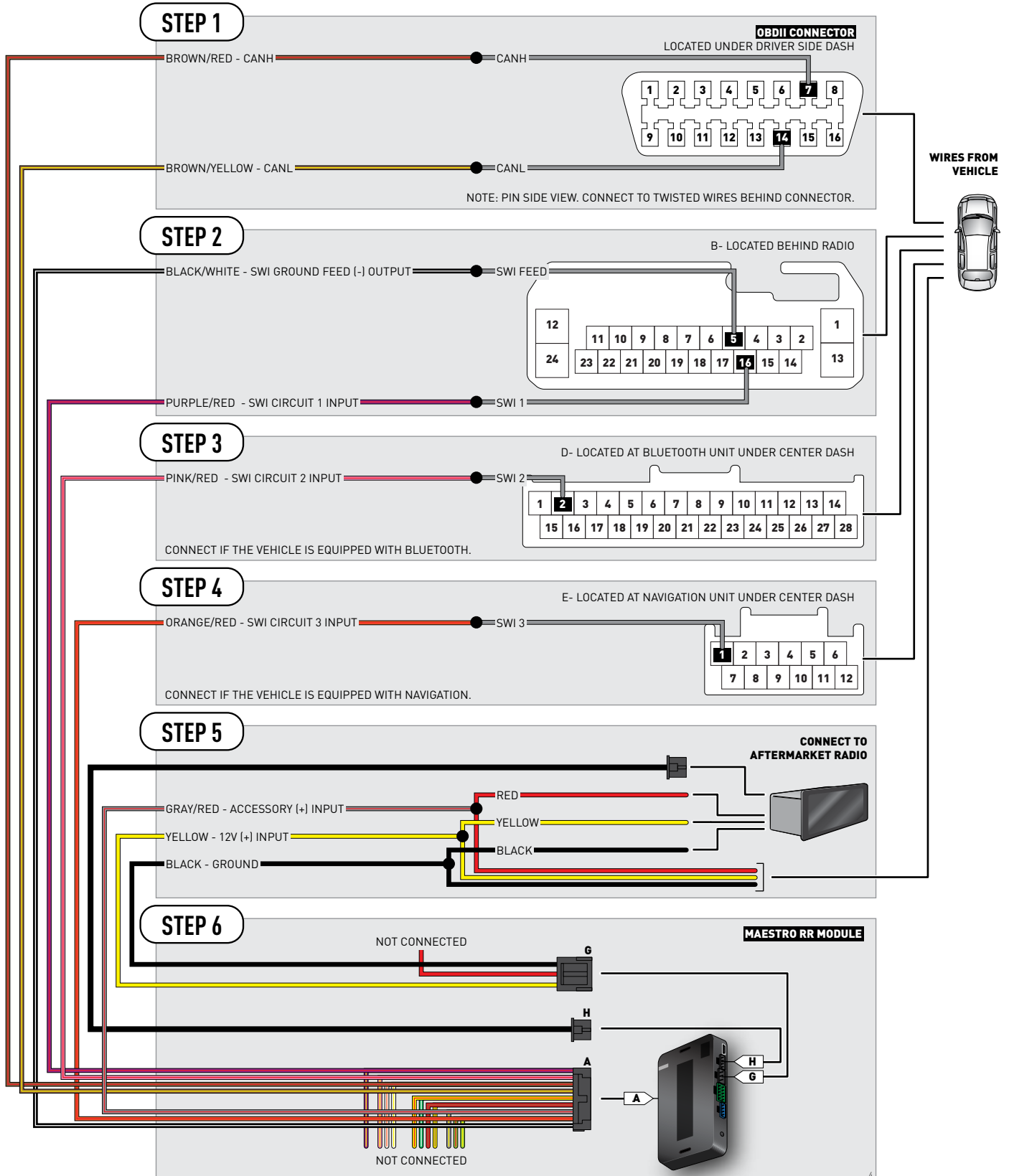



# VEHICLE WIRE REFERENCE CHART

Wire Description	Connector Name	Connector Color	Connector Type	Position	Wire Color	Polarity	Wire Location
CanH	A	~	16 pin	07	White	(DATA)	OBDII connector, under driver side dash
CanL	A	~	16 pin	14	Red	(DATA)	OBDII connector, under driver side dash
SWI 1	B	~	24 pin	16	Pink	(DATA)	Behind radio
SWI 2	D	~	28 pin	02	Blue	(DATA)	Bluetooth unit, under center dash
SWI 3	E	~	12 pin	01	Green	(DATA)	Nav unit, under center dash
SWI Feed	B	~	24 pin	05	Brown	(-)	Behind radio



# INSTALL GUIDE HONDA CRV WITH NAV 2013-2016

RETAINS STEERING WHEEL CONTROLS AND ADDS GAUGES



#### PRODUCTS REQUIRED

iDatalink Maestro RR Radio Replacement Interface  
iDatalink Compatible Radio

#### OPTIONAL ACCESSORIES

None

#### PROGRAMMED FIRMWARE

ADS-RR(SI)-HON01-DS

NOTICE: Automotive Data Solutions Inc. (ADS) recommends having this installation performed by a certified technician. Logos and trademarks used here in are the properties of their respective owners.

# WELCOME

Congratulations on the purchase of your iDatalink Maestro RR Radio replacement solution. You are now a few simple steps away from enjoying your new car radio with enhanced features.

Before starting your installation, please ensure that your iDatalink Maestro module is programmed with the correct firmware for your vehicle and that you carefully review the install guide.

**Please note that Maestro RR will only retain functionalities that were originally available in the vehicle.**

# NEED HELP?

 **1 866 427-2999**

 **[support@idatalink.com](mailto:support@idatalink.com)**

 **[maestro.idatalink.com/support](http://maestro.idatalink.com/support)  
[www.12voltdata.com/forum](http://www.12voltdata.com/forum)**

## TABLE OF CONTENTS

Wiring Diagram	<b>3</b>
Vehicle Wire Reference Chart	<b>4</b>

# WIRING DIAGRAM

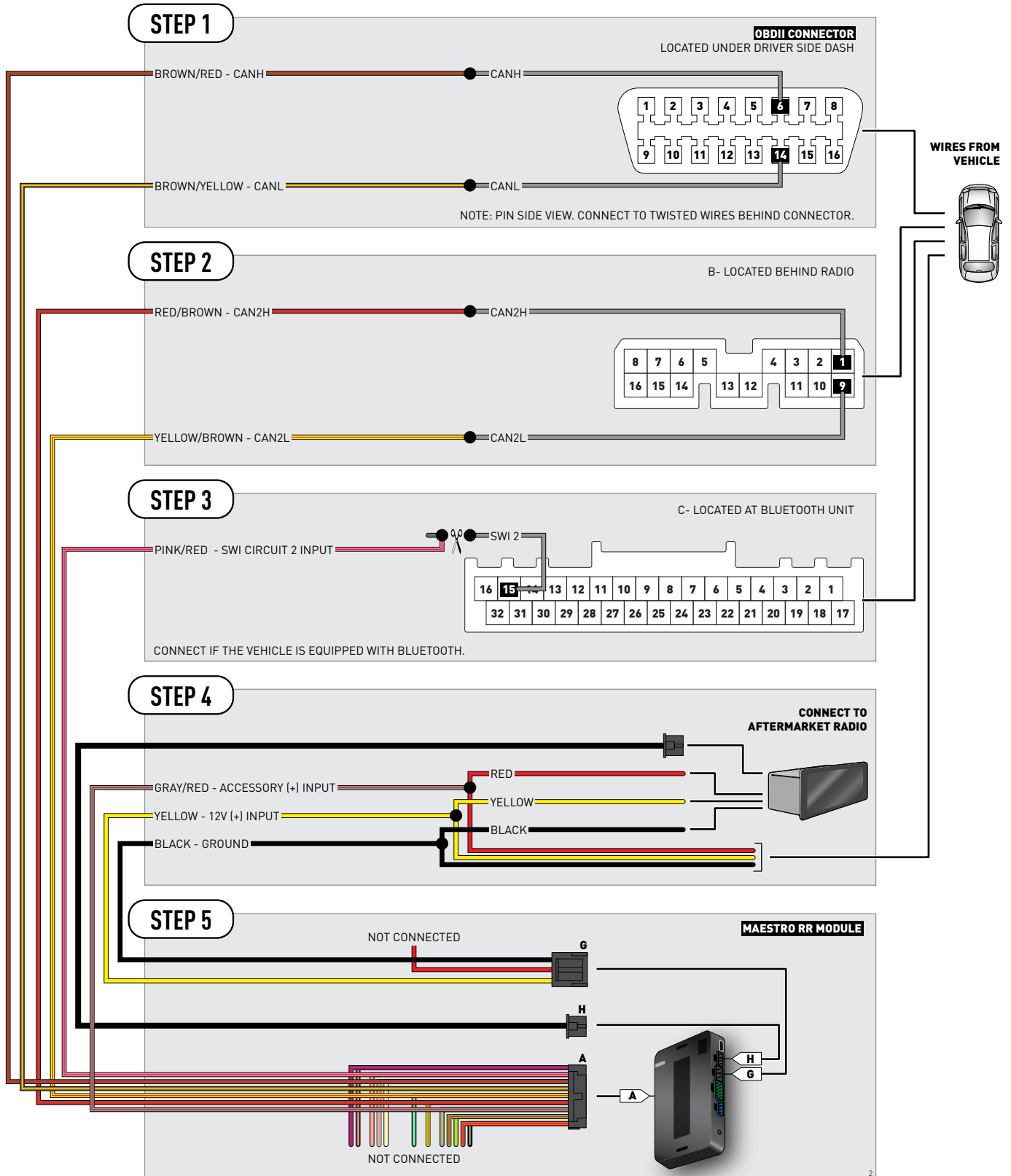

# VEHICLE WIRE REFERENCE CHART

Wire Description	Connector Name	Connector Color	Connector Type	Position	Wire Color	Polarity	Wire Location
CanH	A	~	16 pin	06	White	[DATA]	OBDII connector, under driver side dash
CanL	A	~	16 pin	14	Red	[DATA]	OBDII connector, under driver side dash
Can2H	B	~	20 pin	01	Pink	[DATA]	Behind radio
Can2L	B	~	20 pin	09	Blue	[DATA]	Behind radio
SWI 2	C	~	32 pin	15	Yellow	[DATA]	Bluetooth unit, center dash in front of shifter



# INSTALL GUIDE HONDA CRV WITHOUT NAV 2007-2012

RETAINS STEERING WHEEL CONTROLS AND ADDS GAUGES



#### PRODUCTS REQUIRED

iDatalink Maestro RR Radio Replacement Interface  
iDatalink Compatible Radio

#### OPTIONAL ACCESSORIES

None

#### PROGRAMMED FIRMWARE

ADS-RR(SI)-HON01-DS

NOTICE: Automotive Data Solutions Inc. (ADS) recommends having this installation performed by a certified technician. Logos and trademarks used here in are the properties of their respective owners.

# WELCOME

Congratulations on the purchase of your iDatalink Maestro RR Radio replacement solution. You are now a few simple steps away from enjoying your new car radio with enhanced features.

Before starting your installation, please ensure that your iDatalink Maestro module is programmed with the correct firmware for your vehicle and that you carefully review the install guide.

**Please note that Maestro RR will only retain functionalities that were originally available in the vehicle.**

# NEED HELP?

 **1 866 427-2999**

 [support@idatalink.com](mailto:support@idatalink.com)

 [maestro.idatalink.com/support](http://maestro.idatalink.com/support)  
[www.12voltdata.com/forum](http://www.12voltdata.com/forum)

## TABLE OF CONTENTS

Wiring Diagram	<b>3</b>
Vehicle Wire Reference Chart	<b>4</b>

# WIRING DIAGRAM

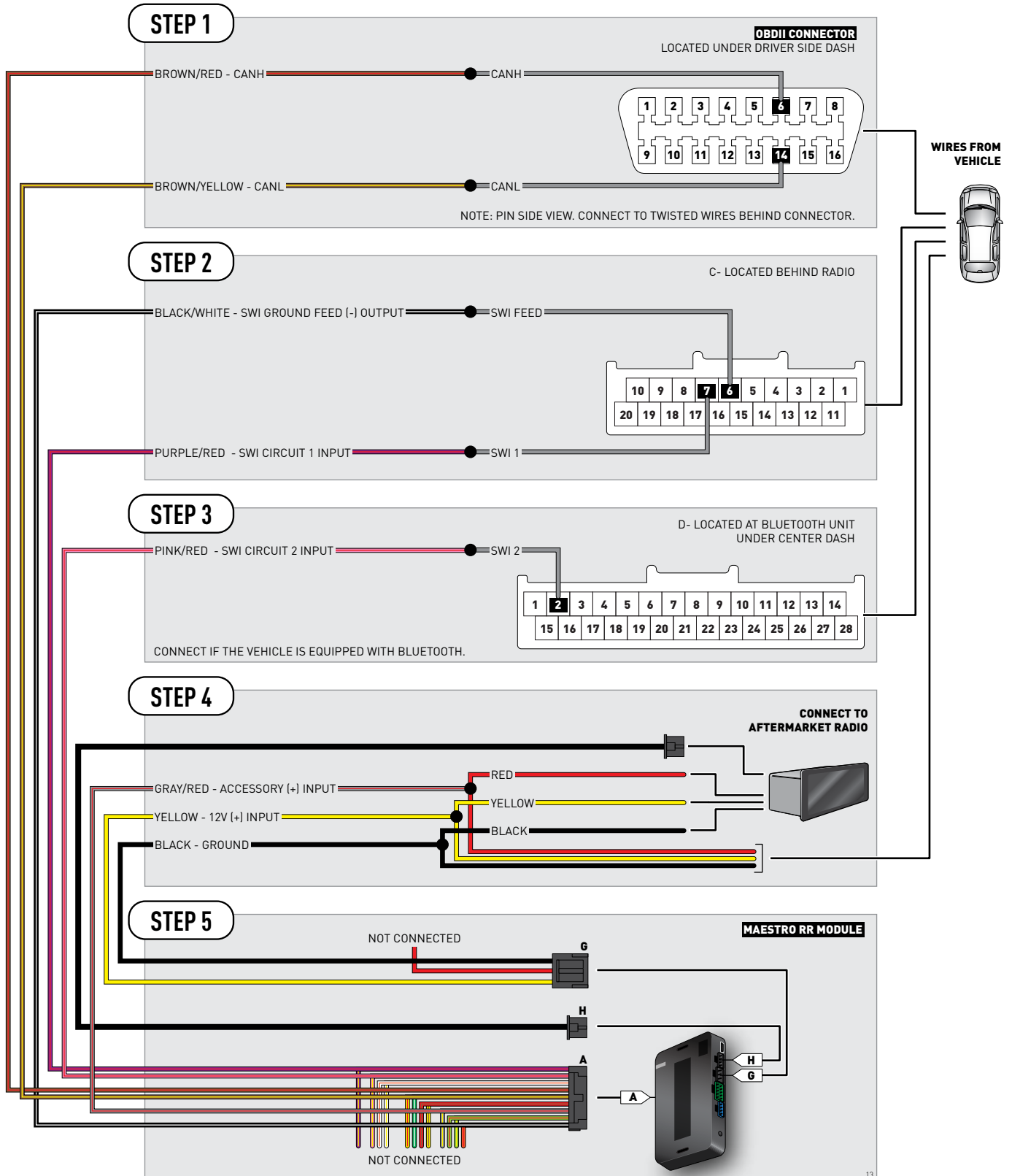



# VEHICLE WIRE REFERENCE CHART

Wire Description	Connector Name	Connector Color	Connector Type	Position	Wire Color	Polarity	Wire Location
CanH	A	~	16 pin	06	White	[DATA]	OBDII connector, under driver side dash
CanL	A	~	16 pin	14	Red	[DATA]	OBDII connector, under driver side dash
SWI 1	C	~	20 pin	07	Pink	[DATA]	Behind radio
SWI 2	D	~	28 pin	02	LtBlue	[DATA]	Bluetooth unit, under center dash
SWI Feed	C	~	20 pin	06	Brown	(-)	Behind radio



# INSTALL GUIDE HONDA CRV WITHOUT NAV 2013-2016

RETAINS STEERING WHEEL CONTROLS AND ADDS GAUGES



#### PRODUCTS REQUIRED

iDatalink Maestro RR Radio Replacement Interface  
iDatalink Compatible Radio

#### OPTIONAL ACCESSORIES

None

#### PROGRAMMED FIRMWARE

ADS-RR(SI)-HON01-DS

NOTICE: Automotive Data Solutions Inc. (ADS) recommends having this installation performed by a certified technician. Logos and trademarks used here in are the properties of their respective owners.

# WELCOME

Congratulations on the purchase of your iDatalink Maestro RR Radio replacement solution. You are now a few simple steps away from enjoying your new car radio with enhanced features.

Before starting your installation, please ensure that your iDatalink Maestro module is programmed with the correct firmware for your vehicle and that you carefully review the install guide.

**Please note that Maestro RR will only retain functionalities that were originally available in the vehicle.**

# NEED HELP?

 **1 866 427-2999**

 [support@idatalink.com](mailto:support@idatalink.com)

 [maestro.idatalink.com/support](http://maestro.idatalink.com/support)  
[www.12voltdata.com/forum](http://www.12voltdata.com/forum)

## TABLE OF CONTENTS

Wiring Diagram	<b>3</b>
Vehicle Wire Reference Chart	<b>4</b>

# WIRING DIAGRAM

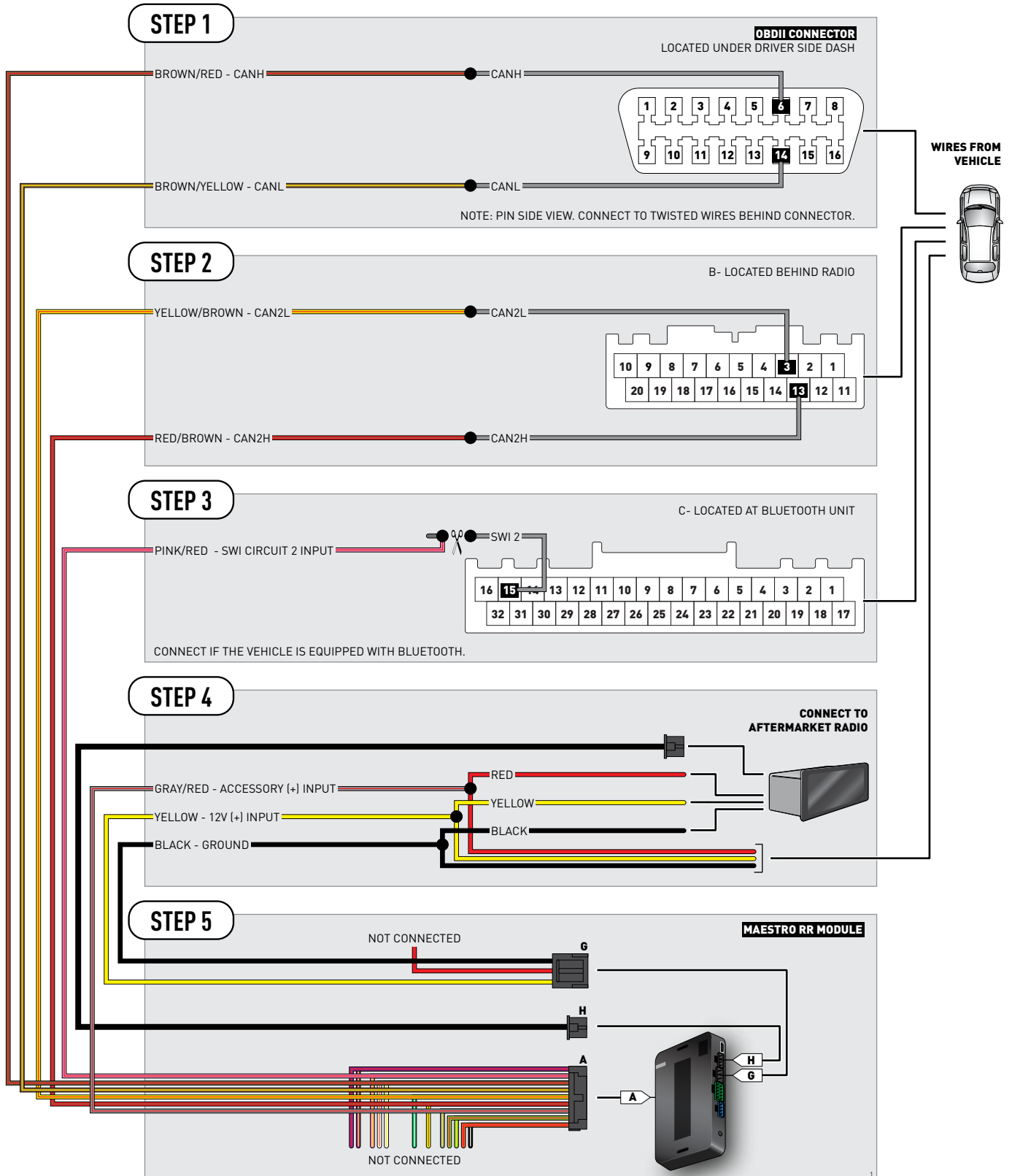

# VEHICLE WIRE REFERENCE CHART

Wire Description	Connector Name	Connector Color	Connector Type	Position	Wire Color	Polarity	Wire Location
CanH	A	~	16 pin	06	White	(DATA)	OBDII connector, under driver side dash
CanL	A	~	16 pin	14	Red	(DATA)	OBDII connector, under driver side dash
Can2H	B	~	20 pin	13	Pink	(DATA)	Behind radio
Can2L	B	~	20 pin	03	Blue	(DATA)	Behind radio
SWI 2	C	~	32 pin	15	Yellow	(DATA)	Bluetooth unit, center dash in front of shifter



# INSTALL GUIDE HONDA CRZ 2011-2015

RETAINS STEERING WHEEL CONTROLS AND ADDS GAUGES



#### PRODUCTS REQUIRED

iDatalink Maestro RR Radio Replacement Interface  
iDatalink Compatible Radio

#### OPTIONAL ACCESSORIES

None

#### PROGRAMMED FIRMWARE

ADS-RR(SI)-HON01-DS

NOTICE: Automotive Data Solutions Inc. (ADS) recommends having this installation performed by a certified technician. Logos and trademarks used here in are the properties of their respective owners.

# WELCOME

Congratulations on the purchase of your iDatalink Maestro RR Radio replacement solution. You are now a few simple steps away from enjoying your new car radio with enhanced features.

Before starting your installation, please ensure that your iDatalink Maestro module is programmed with the correct firmware for your vehicle and that you carefully review the install guide.

**Please note that Maestro RR will only retain functionalities that were originally available in the vehicle.**

# NEED HELP?

 **1 866 427-2999**

 [support@idatalink.com](mailto:support@idatalink.com)

 [maestro.idatalink.com/support](http://maestro.idatalink.com/support)  
[www.12voltdata.com/forum](http://www.12voltdata.com/forum)

## TABLE OF CONTENTS

Wiring Diagram	<b>3</b>
Vehicle Wire Reference Chart	<b>4</b>

# WIRING DIAGRAM

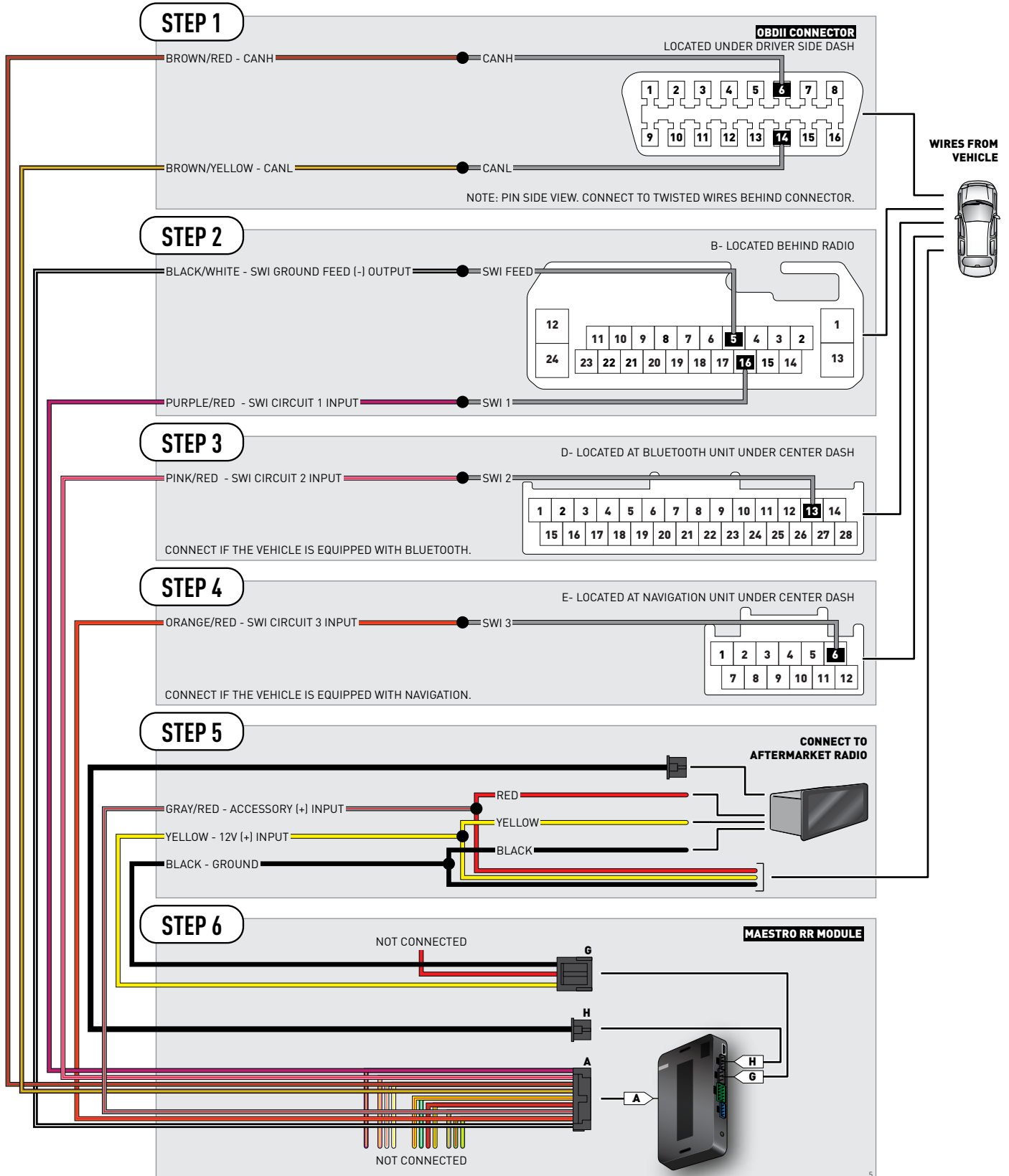



# VEHICLE WIRE REFERENCE CHART

Wire Description	Connector Name	Connector Color	Connector Type	Position	Wire Color	Polarity	Wire Location
CanH	A	~	16 pin	06	Green	(DATA)	OBDII connector, under driver side dash
CanL	A	~	16 pin	14	Pink	(DATA)	OBDII connector, under driver side dash
SWI 1	B	~	24 pin	16	Pink	(DATA)	Behind radio
SWI 2	D	~	28 pin	13	Green	(DATA)	Bluetooth unit, under center dash
SWI 3	E	~	12 pin	06	Orange	(DATA)	Nav unit, under center dash
SWI Feed	B	~	24 pin	05	Brown	(-)	Behind radio



# INSTALL GUIDE HONDA ELEMENT 2007-2011

RETAINS STEERING WHEEL CONTROLS AND ADDS GAUGES



---

#### PRODUCTS REQUIRED

iDatalink Maestro RR Radio Replacement Interface  
iDatalink Compatible Radio

#### OPTIONAL ACCESSORIES

None

#### PROGRAMMED FIRMWARE

ADS-RR(SI)-HON01-DS

NOTICE: Automotive Data Solutions Inc. (ADS) recommends having this installation performed by a certified technician. Logos and trademarks used here in are the properties of their respective owners.

# WELCOME

Congratulations on the purchase of your iDatalink Maestro RR Radio replacement solution. You are now a few simple steps away from enjoying your new car radio with enhanced features.

Before starting your installation, please ensure that your iDatalink Maestro module is programmed with the correct firmware for your vehicle and that you carefully review the install guide.

**Please note that Maestro RR will only retain functionalities that were originally available in the vehicle.**

# NEED HELP?

 **1 866 427-2999**

 [support@idatalink.com](mailto:support@idatalink.com)

 [maestro.idatalink.com/support](http://maestro.idatalink.com/support)  
[www.12voltdata.com/forum](http://www.12voltdata.com/forum)

## TABLE OF CONTENTS

Wiring Diagram	<b>3</b>
Vehicle Wire Reference Chart	<b>4</b>

# WIRING DIAGRAM

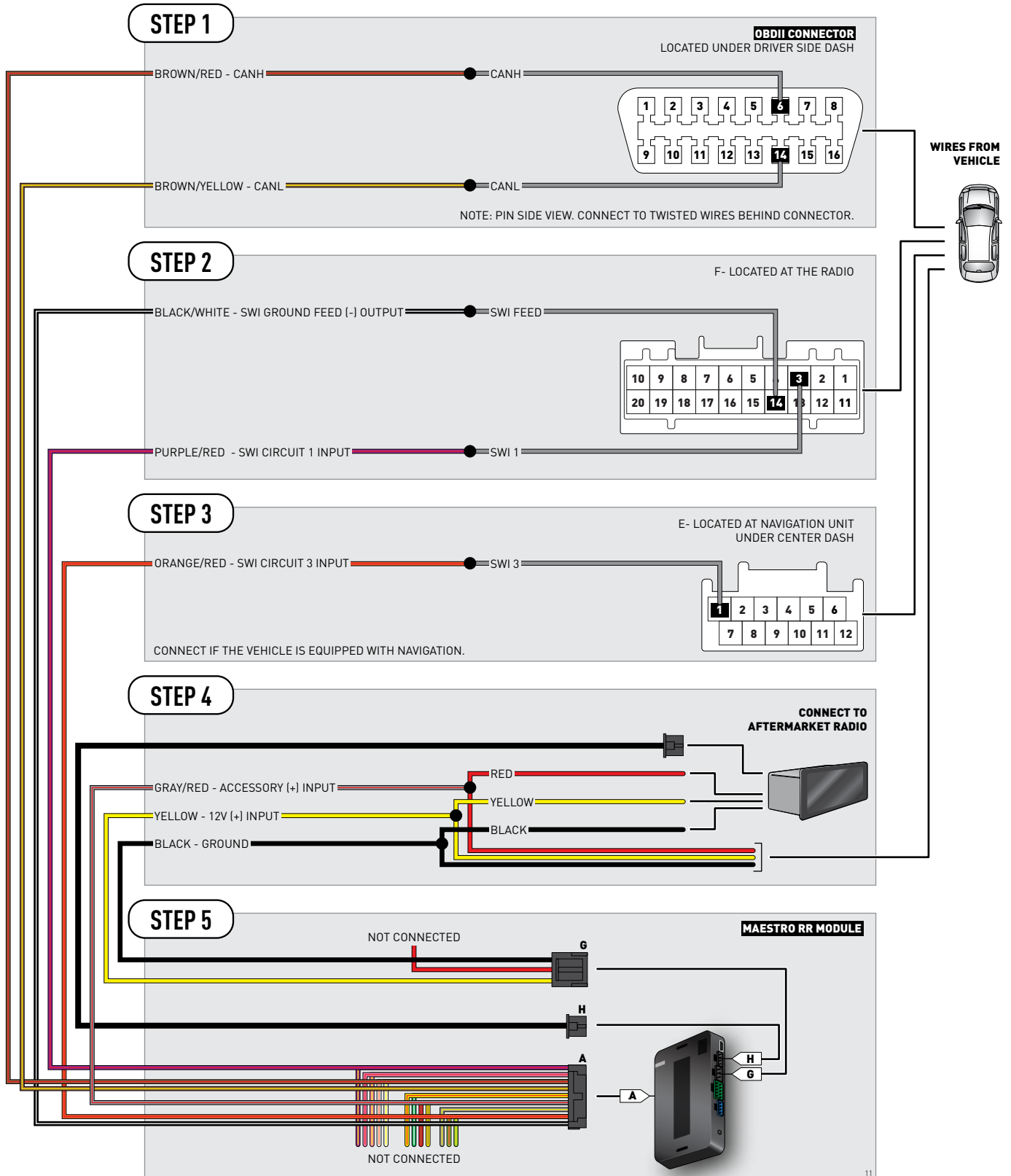

11

# VEHICLE WIRE REFERENCE CHART

Wire Description	Connector Name	Connector Color	Connector Type	Position	Wire Color	Polarity	Wire Location
CanH	A	~	16 pin	06	White	[DATA]	OBDII connector, under driver side dash
CanL	A	~	16 pin	14	Red	[DATA]	OBDII connector, under driver side dash
SWI 1	F	~	20 pin	03	Green/Red	[DATA]	At the radio
SWI 3	E	~	12 pin	01	Green	[DATA]	Nav unit, under center dash
SWI Feed	F	~	20 pin	14	Brown	(-)	At the radio



# INSTALL GUIDE HONDA FIT 2009-2014

RETAINS STEERING WHEEL CONTROLS AND ADDS GAUGES



---

#### PRODUCTS REQUIRED

iDatalink Maestro RR Radio Replacement Interface  
iDatalink Compatible Radio

#### OPTIONAL ACCESSORIES

None

#### PROGRAMMED FIRMWARE

ADS-RR(SI)-HON01-DS

NOTICE: Automotive Data Solutions Inc. (ADS) recommends having this installation performed by a certified technician. Logos and trademarks used here in are the properties of their respective owners.

# WELCOME

Congratulations on the purchase of your iDatalink Maestro RR Radio replacement solution. You are now a few simple steps away from enjoying your new car radio with enhanced features.

Before starting your installation, please ensure that your iDatalink Maestro module is programmed with the correct firmware for your vehicle and that you carefully review the install guide.

**Please note that Maestro RR will only retain functionalities that were originally available in the vehicle.**

# NEED HELP?

 **1 866 427-2999**

 [support@idatalink.com](mailto:support@idatalink.com)

 [maestro.idatalink.com/support](http://maestro.idatalink.com/support)  
[www.12voltdata.com/forum](http://www.12voltdata.com/forum)

## TABLE OF CONTENTS

Wiring Diagram	<b>3</b>
Vehicle Wire Reference Chart	<b>4</b>

# WIRING DIAGRAM

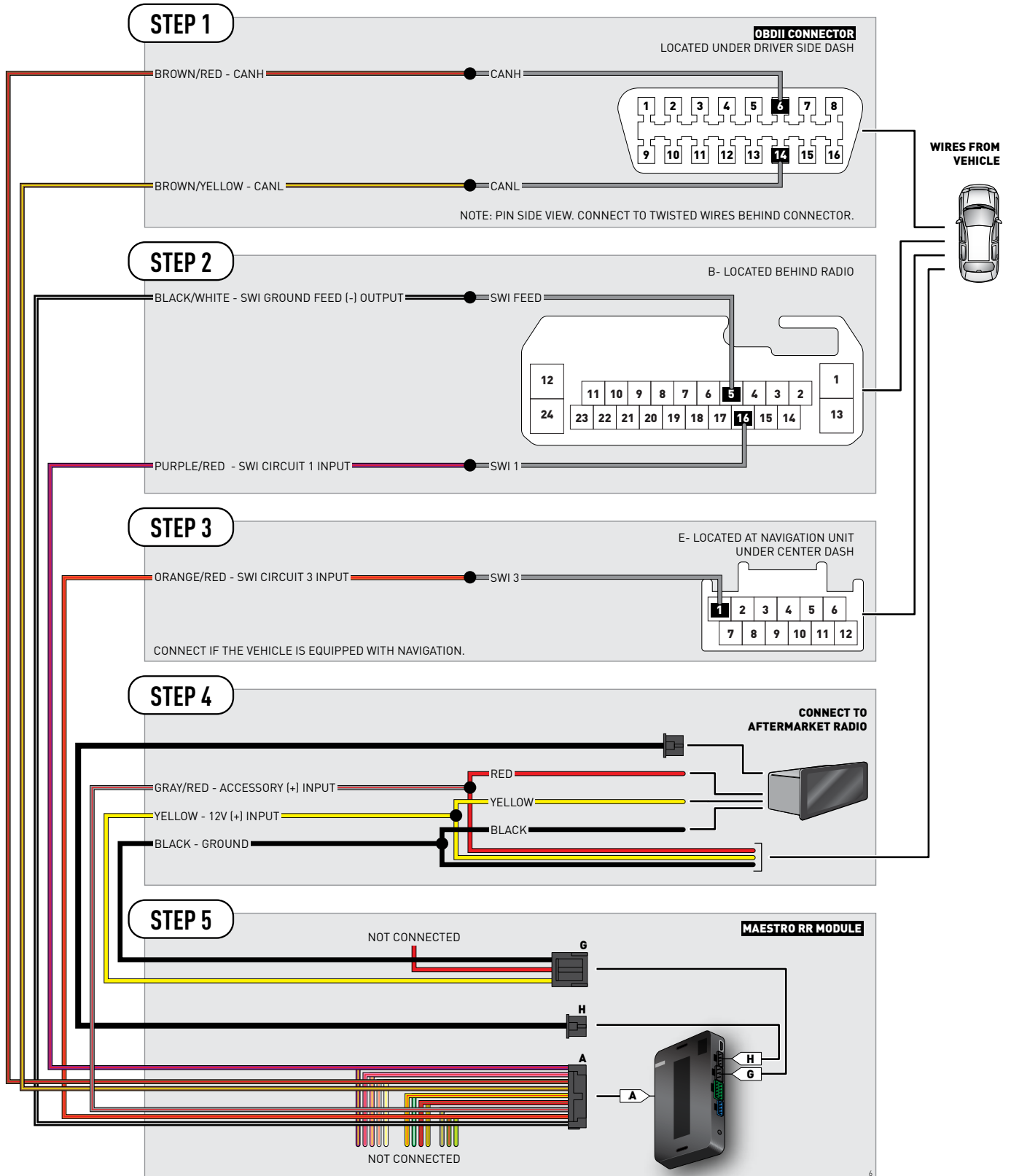



# VEHICLE WIRE REFERENCE CHART

Wire Description	Connector Name	Connector Color	Connector Type	Position	Wire Color	Polarity	Wire Location
CanH	A	~	16 pin	06	White	[DATA]	OBDII connector, under driver side dash
CanL	A	~	16 pin	14	Red	[DATA]	OBDII connector, under driver side dash
SWI 1	B	~	24 pin	16	Pink	[DATA]	Behind radio
SWI 3	E	~	12 pin	01	Green	[DATA]	Nav unit, under center dash
SWI Feed	B	~	24 pin	05	White	(-)	Behind radio



# INSTALL GUIDE HONDA INSIGHT 2010-2014

RETAINS STEERING WHEEL CONTROLS AND ADDS GAUGES



---

#### PRODUCTS REQUIRED

iDatalink Maestro RR Radio Replacement Interface  
iDatalink Compatible Radio

#### OPTIONAL ACCESSORIES

None

#### PROGRAMMED FIRMWARE

ADS-RR(SI)-HON01-DS

NOTICE: Automotive Data Solutions Inc. (ADS) recommends having this installation performed by a certified technician. Logos and trademarks used here in are the properties of their respective owners.

# WELCOME

Congratulations on the purchase of your iDatalink Maestro RR Radio replacement solution. You are now a few simple steps away from enjoying your new car radio with enhanced features.

Before starting your installation, please ensure that your iDatalink Maestro module is programmed with the correct firmware for your vehicle and that you carefully review the install guide.

**Please note that Maestro RR will only retain functionalities that were originally available in the vehicle.**

# NEED HELP?

 **1 866 427-2999**

 [support@idatalink.com](mailto:support@idatalink.com)

 [maestro.idatalink.com/support](http://maestro.idatalink.com/support)  
[www.12voltdata.com/forum](http://www.12voltdata.com/forum)

## TABLE OF CONTENTS

Wiring Diagram	<b>3</b>
Vehicle Wire Reference Chart	<b>4</b>

# WIRING DIAGRAM

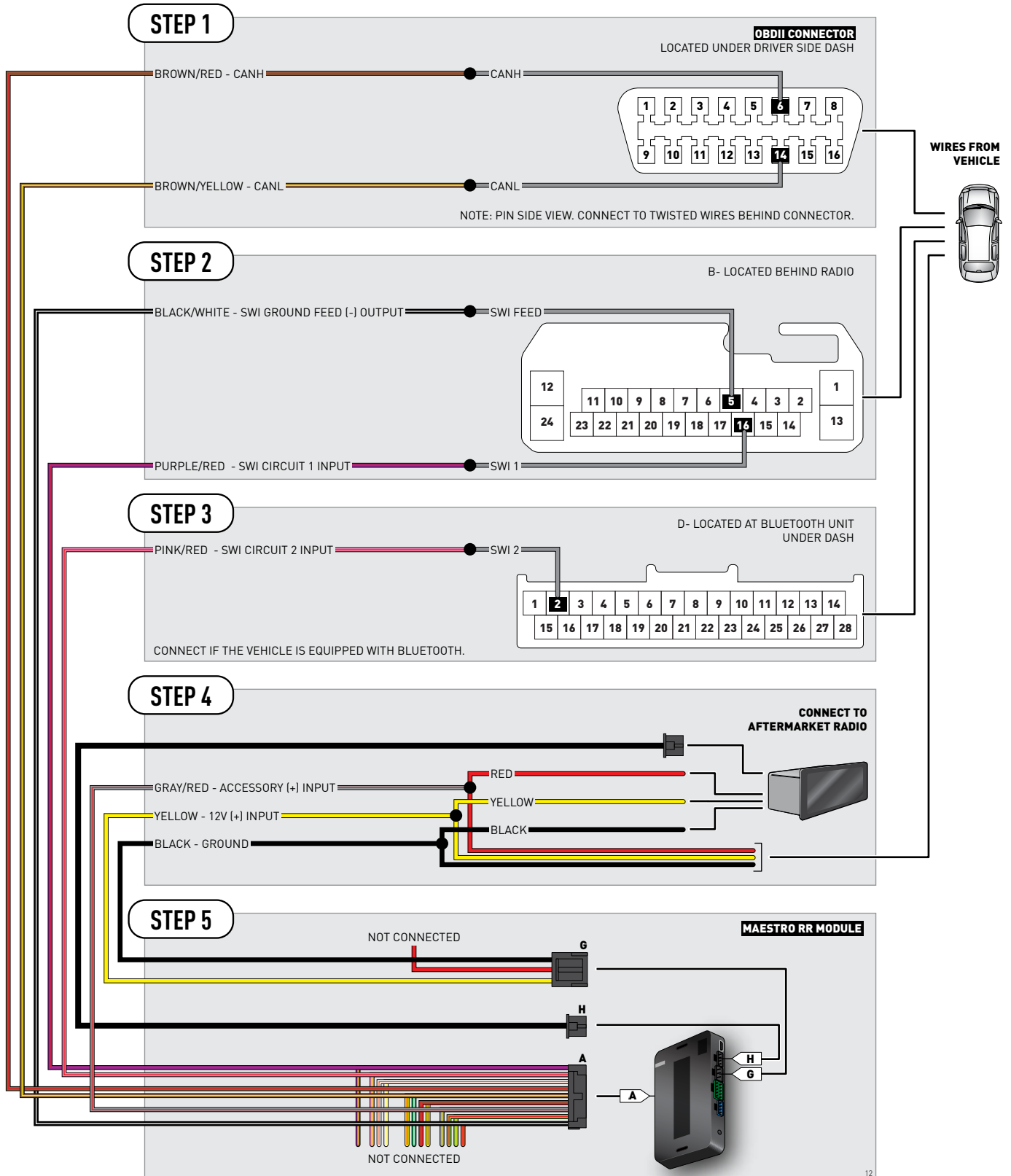

# VEHICLE WIRE REFERENCE CHART

Wire Description	Connector Name	Connector Color	Connector Type	Position	Wire Color	Polarity	Wire Location
CanH	A	~	16 pin	06	White	[DATA]	OBDII connector, under driver side dash
CanL	A	~	16 pin	14	Red	[DATA]	OBDII connector, under driver side dash
SWI 1	B	~	24 pin	16	Pink	[DATA]	Behind radio
SWI 2	D	~	28 pin	02	Green	[DATA]	Bluetooth unit, under center dash
SWI Feed	B	~	24 pin	05	White	(-)	Behind radio



# INSTALL GUIDE HONDA ODYSSEY 2007

RETAINS STEERING WHEEL CONTROLS AND ADDS GAUGES



---

#### PRODUCTS REQUIRED

iDatalink Maestro RR Radio Replacement Interface  
iDatalink Compatible Radio

#### OPTIONAL ACCESSORIES

None

#### PROGRAMMED FIRMWARE

ADS-RR(SI)-HON01-DS

NOTICE: Automotive Data Solutions Inc. (ADS) recommends having this installation performed by a certified technician. Logos and trademarks used here in are the properties of their respective owners.

# WELCOME

Congratulations on the purchase of your iDatalink Maestro RR Radio replacement solution. You are now a few simple steps away from enjoying your new car radio with enhanced features.

Before starting your installation, please ensure that your iDatalink Maestro module is programmed with the correct firmware for your vehicle and that you carefully review the install guide.

**Please note that Maestro RR will only retain functionalities that were originally available in the vehicle.**

# NEED HELP?

 **1 866 427-2999**

 [support@idatalink.com](mailto:support@idatalink.com)

 [maestro.idatalink.com/support](http://maestro.idatalink.com/support)  
[www.12voltdata.com/forum](http://www.12voltdata.com/forum)

## TABLE OF CONTENTS

Wiring Diagram	<b>3</b>
Vehicle Wire Reference Chart	<b>4</b>

# WIRING DIAGRAM

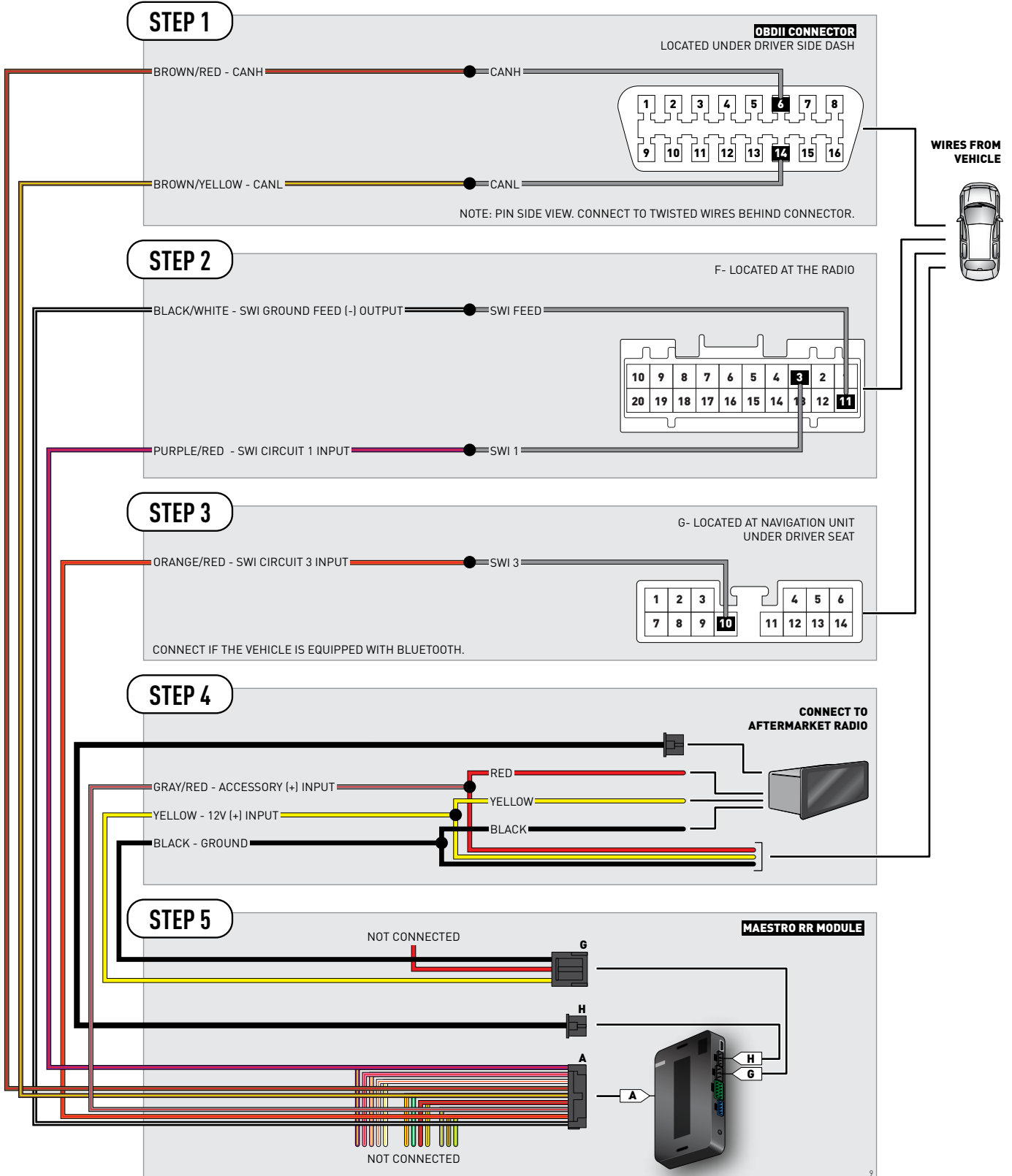



# VEHICLE WIRE REFERENCE CHART

Wire Description	Connector Name	Connector Color	Connector Type	Position	Wire Color	Polarity	Wire Location
CanH	A	~	16 pin	06	White	[DATA]	OBDII connector, under driver side dash
CanL	A	~	16 pin	14	Red	[DATA]	OBDII connector, under driver side dash
SWI 1	F	~	20 pin	03	White	[DATA]	At the radio
SWI 3	G	~	14 pin	10	Gray	[DATA]	At Nav unit, under driver seat
SWI Feed	F	~	20 pin	11	Brown	(-)	At the radio



# INSTALL GUIDE HONDA ODYSSEY 2008-2010

RETAINS STEERING WHEEL CONTROLS AND ADDS GAUGES



#### PRODUCTS REQUIRED

iDatalink Maestro RR Radio Replacement Interface  
iDatalink Compatible Radio

#### OPTIONAL ACCESSORIES

None

#### PROGRAMMED FIRMWARE

ADS-RR(SI)-HON01-DS

NOTICE: Automotive Data Solutions Inc. (ADS) recommends having this installation performed by a certified technician. Logos and trademarks used here in are the properties of their respective owners.

# WELCOME

Congratulations on the purchase of your iDatalink Maestro RR Radio replacement solution. You are now a few simple steps away from enjoying your new car radio with enhanced features.

Before starting your installation, please ensure that your iDatalink Maestro module is programmed with the correct firmware for your vehicle and that you carefully review the install guide.

**Please note that Maestro RR will only retain functionalities that were originally available in the vehicle.**

# NEED HELP?

 **1 866 427-2999**

 [support@idatalink.com](mailto:support@idatalink.com)

 [maestro.idatalink.com/support](http://maestro.idatalink.com/support)  
[www.12voltdata.com/forum](http://www.12voltdata.com/forum)

## TABLE OF CONTENTS

Wiring Diagram	<b>3</b>
Vehicle Wire Reference Chart	<b>4</b>

# WIRING DIAGRAM

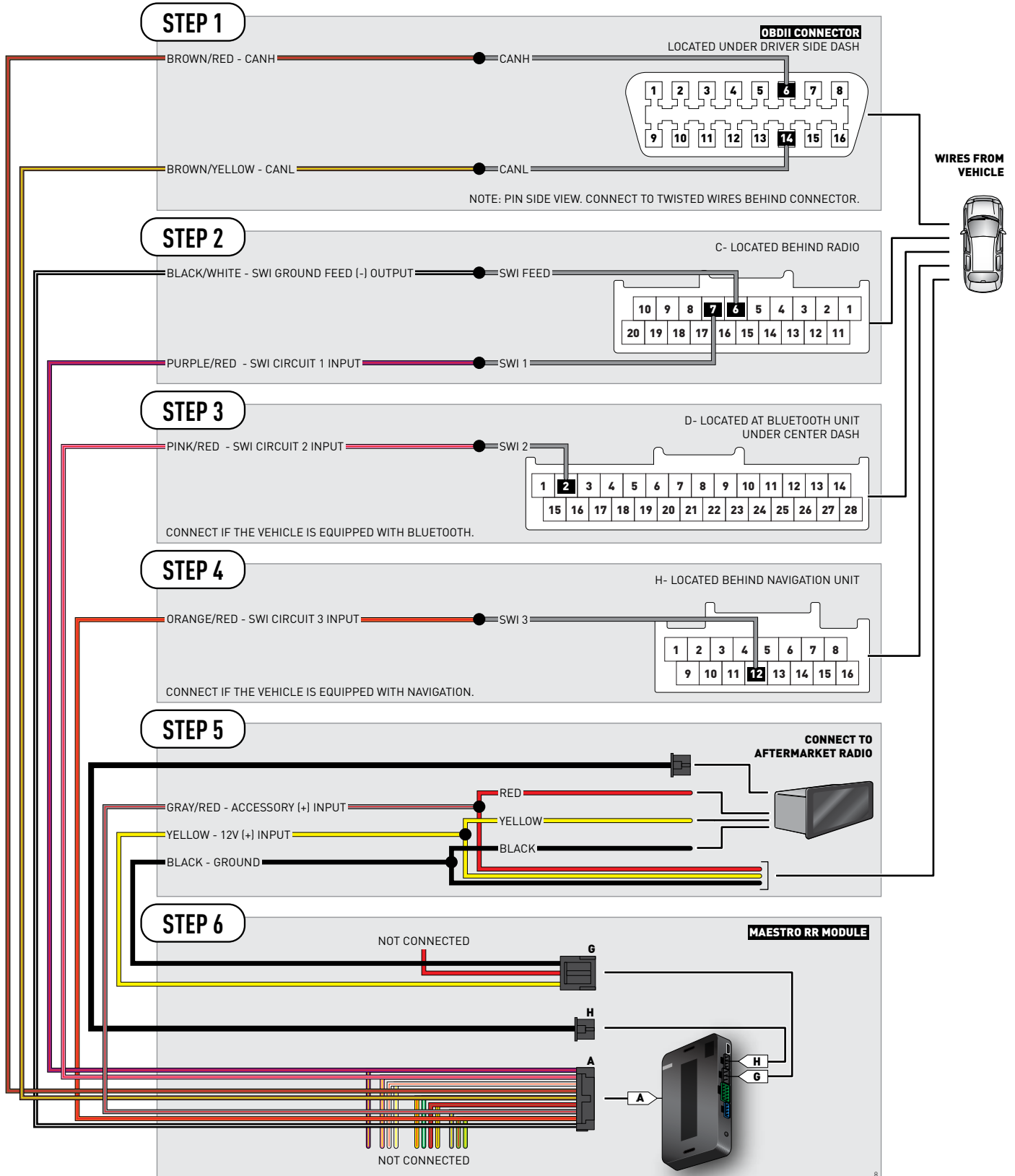

# VEHICLE WIRE REFERENCE CHART

Wire Description	Connector Name	Connector Color	Connector Type	Position	Wire Color	Polarity	Wire Location
CanH	A	~	16 pin	06	White	(DATA)	OBDII connector, under driver side dash
CanL	A	~	16 pin	14	Red	(DATA)	OBDII connector, under driver side dash
SWI 1	C	~	20 pin	07	White	(DATA)	Behind radio
SWI 2	D	~	28 pin	02	Blue	(DATA)	Bluetooth unit, under center dash
SWI 3	H	~	16 pin	12	Gray	(DATA)	Behind Nav unit
SWI Feed	C	~	20 pin	06	Brown	(-)	Behind radio



# INSTALL GUIDE HONDA ODYSSEY 2011-2016

RETAINS STEERING WHEEL CONTROLS AND ADDS GAUGES



---

#### PRODUCTS REQUIRED

iDatalink Maestro RR Radio Replacement Interface  
iDatalink Compatible Radio

#### OPTIONAL ACCESSORIES

None

#### PROGRAMMED FIRMWARE

ADS-RR(SI)-HON01-DS

NOTICE: Automotive Data Solutions Inc. (ADS) recommends having this installation performed by a certified technician. Logos and trademarks used here in are the properties of their respective owners.

# WELCOME

Congratulations on the purchase of your iDatalink Maestro RR Radio replacement solution. You are now a few simple steps away from enjoying your new car radio with enhanced features.

Before starting your installation, please ensure that your iDatalink Maestro module is programmed with the correct firmware for your vehicle and that you carefully review the install guide.

**Please note that Maestro RR will only retain functionalities that were originally available in the vehicle.**

# NEED HELP?

 **1 866 427-2999**

 [support@idatalink.com](mailto:support@idatalink.com)

 [maestro.idatalink.com/support](http://maestro.idatalink.com/support)  
[www.12voltdata.com/forum](http://www.12voltdata.com/forum)

## TABLE OF CONTENTS

Wiring Diagram	<b>3</b>
Vehicle Wire Reference Chart	<b>4</b>

# WIRING DIAGRAM

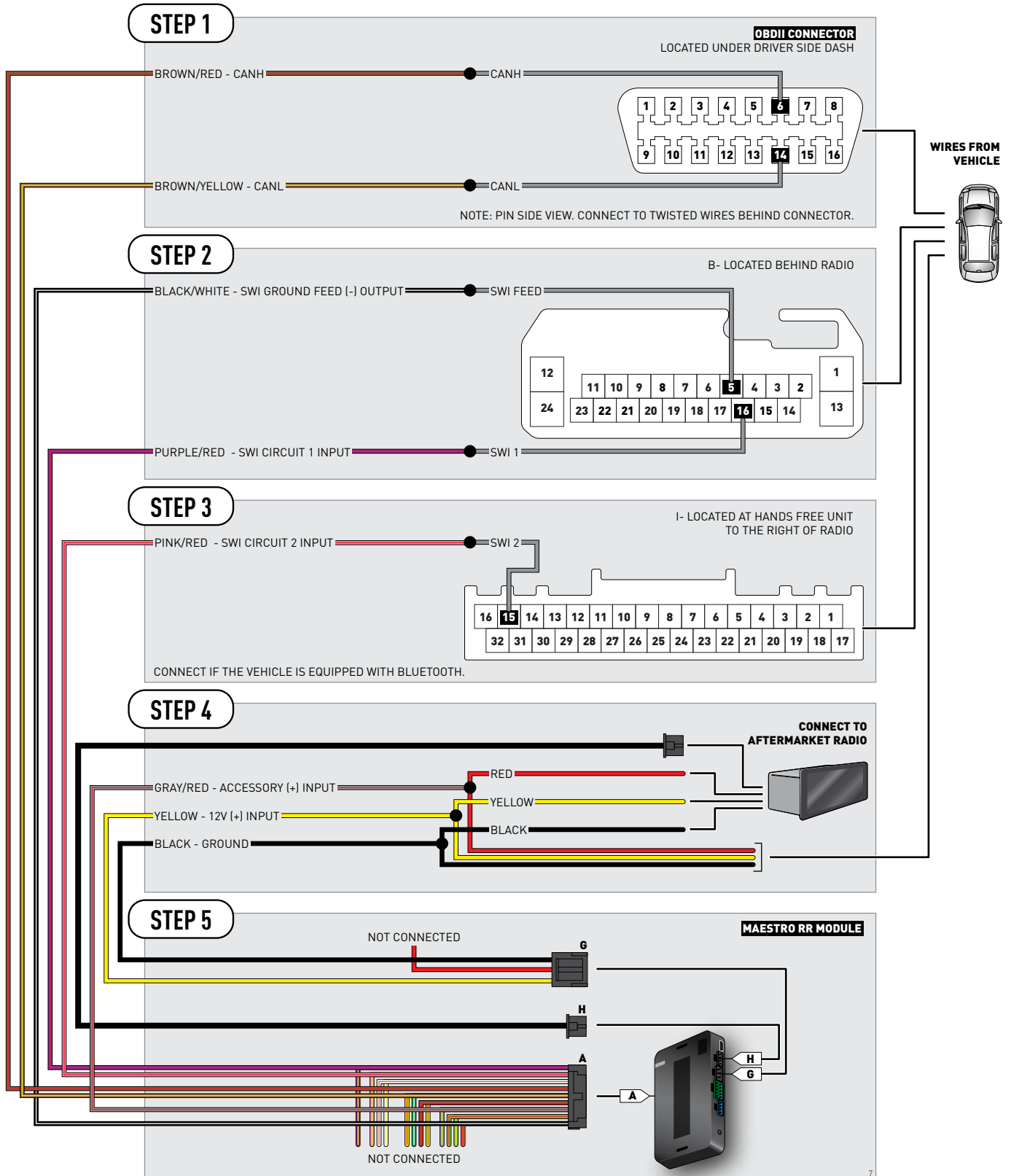



# VEHICLE WIRE REFERENCE CHART

Wire Description	Connector Name	Connector Color	Connector Type	Position	Wire Color	Polarity	Wire Location
CanH	A	~	16 pin	06	White	[DATA]	OBDII connector, under driver side dash
CanL	A	~	16 pin	14	Black	[DATA]	OBDII connector, under driver side dash
SWI 1	B	~	24 pin	16	Pink	[DATA]	Behind radio
SWI 2	I	~	32 pin	15	Green	[DATA]	Hands free unit, right of radio
SWI Feed	B	~	24 pin	05	Orange	(-)	Behind radio



# INSTALL GUIDE HONDA PILOT 2009-2015

RETAINS STEERING WHEEL CONTROLS AND ADDS GAUGES



#### PRODUCTS REQUIRED

iDatalink Maestro RR Radio Replacement Interface  
iDatalink Compatible Radio

#### OPTIONAL ACCESSORIES

None

#### PROGRAMMED FIRMWARE

ADS-RR(SI)-HON01-DS

NOTICE: Automotive Data Solutions Inc. (ADS) recommends having this installation performed by a certified technician. Logos and trademarks used here in are the properties of their respective owners.

# WELCOME

Congratulations on the purchase of your iDatalink Maestro RR Radio replacement solution. You are now a few simple steps away from enjoying your new car radio with enhanced features.

Before starting your installation, please ensure that your iDatalink Maestro module is programmed with the correct firmware for your vehicle and that you carefully review the install guide.

**Please note that Maestro RR will only retain functionalities that were originally available in the vehicle.**

# NEED HELP?

 **1 866 427-2999**

 [support@idatalink.com](mailto:support@idatalink.com)

 [maestro.idatalink.com/support](http://maestro.idatalink.com/support)  
[www.12voltdata.com/forum](http://www.12voltdata.com/forum)

## TABLE OF CONTENTS

Wiring Diagram	<b>3</b>
Vehicle Wire Reference Chart	<b>4</b>

# WIRING DIAGRAM

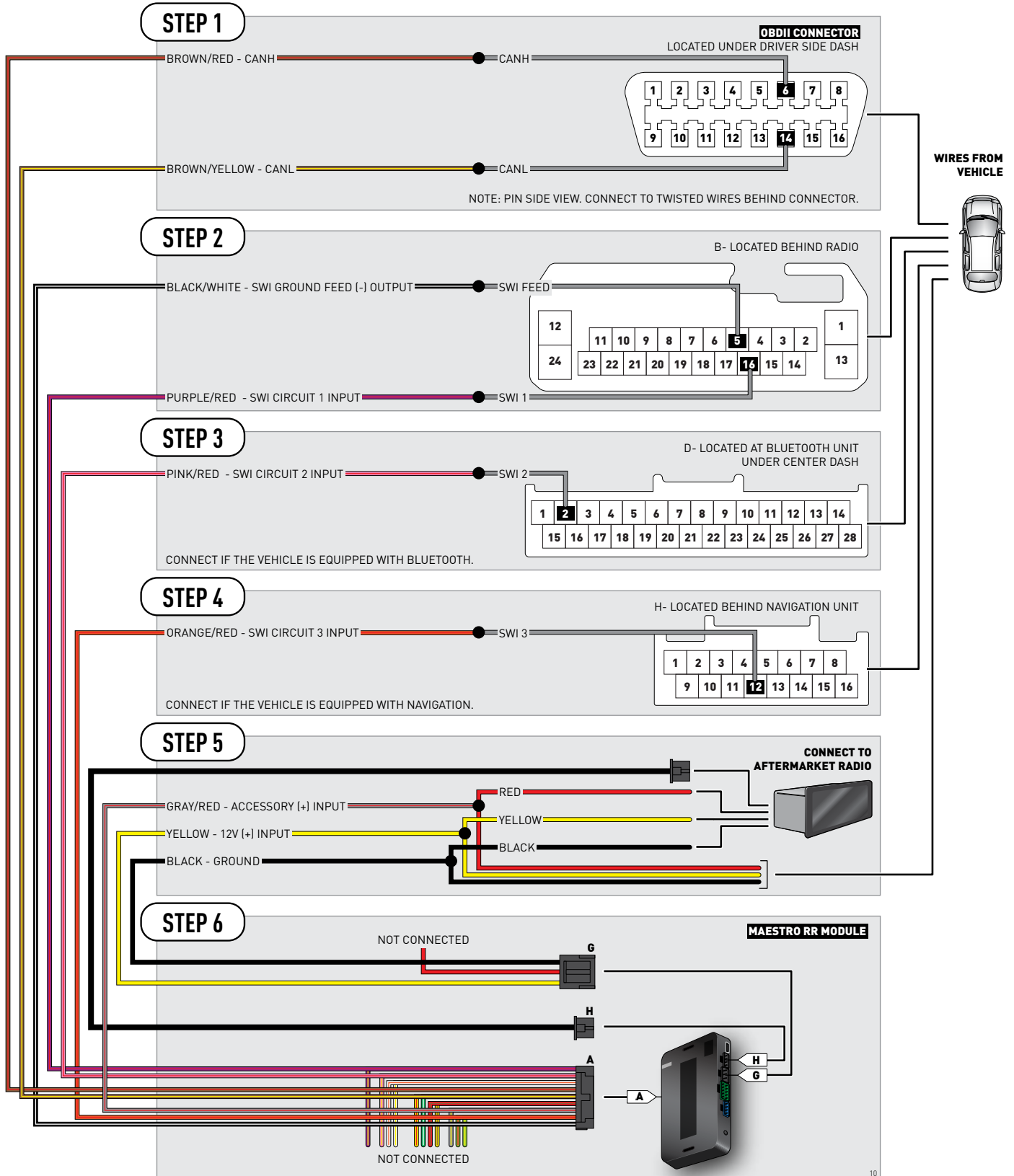

10

# VEHICLE WIRE REFERENCE CHART

Wire Description	Connector Name	Connector Color	Connector Type	Position	Wire Color	Polarity	Wire Location
CanH	A	~	16 pin	06	White	(DATA)	OBDII connector, under driver side dash
CanL	A	~	16 pin	14	Red	(DATA)	OBDII connector, under driver side dash
SWI 1	B	~	24 pin	16	Pink	(DATA)	Behind radio
SWI 2	D	~	28 pin	02	White	(DATA)	Bluetooth unit, under center dash
SWI 3	H	~	16 pin	12	Purple	(DATA)	Behind Nav unit
SWI Feed	B	~	24 pin	05	Brown	(-)	Behind radio



# INSTALL GUIDE HONDA RIDGELINE 2009-2014

RETAINS STEERING WHEEL CONTROLS AND ADDS GAUGES



---

#### PRODUCTS REQUIRED

iDatalink Maestro RR Radio Replacement Interface  
iDatalink Compatible Radio

#### OPTIONAL ACCESSORIES

None

#### PROGRAMMED FIRMWARE

ADS-RR(SI)-HON01-DS

NOTICE: Automotive Data Solutions Inc. (ADS) recommends having this installation performed by a certified technician. Logos and trademarks used here in are the properties of their respective owners.

# WELCOME

Congratulations on the purchase of your iDatalink Maestro RR Radio replacement solution. You are now a few simple steps away from enjoying your new car radio with enhanced features.

Before starting your installation, please ensure that your iDatalink Maestro module is programmed with the correct firmware for your vehicle and that you carefully review the install guide.

**Please note that Maestro RR will only retain functionalities that were originally available in the vehicle.**

# NEED HELP?

 **1 866 427-2999**

 [support@idatalink.com](mailto:support@idatalink.com)

 [maestro.idatalink.com/support](http://maestro.idatalink.com/support)  
[www.12voltdata.com/forum](http://www.12voltdata.com/forum)

## TABLE OF CONTENTS

Wiring Diagram	<b>3</b>
Vehicle Wire Reference Chart	<b>4</b>

# WIRING DIAGRAM

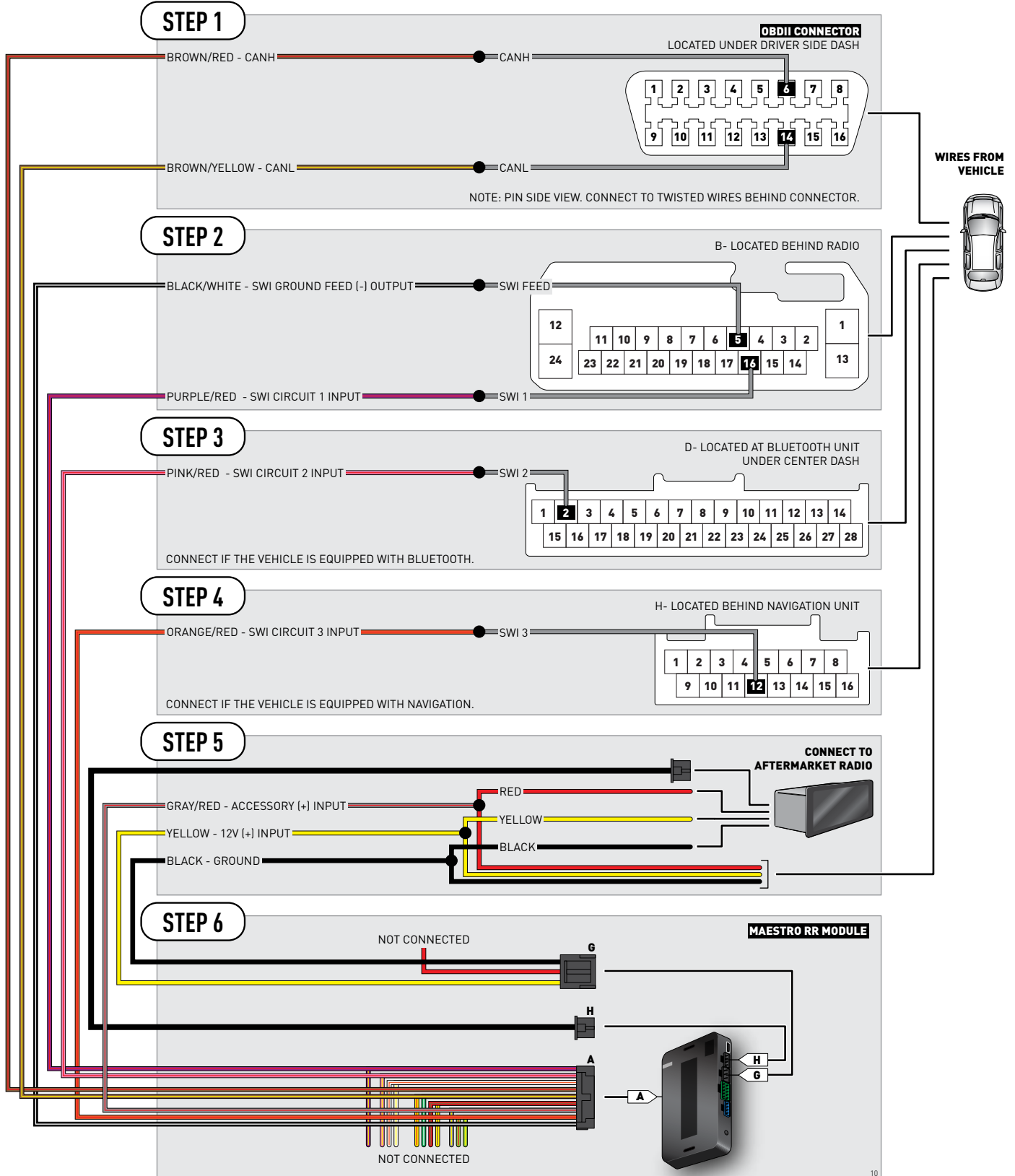



# VEHICLE WIRE REFERENCE CHART

Wire Description	Connector Name	Connector Color	Connector Type	Position	Wire Color	Polarity	Wire Location
CanH	A	~	16 pin	06	White	(DATA)	OBDII connector, under driver side dash
CanL	A	~	16 pin	14	Red	(DATA)	OBDII connector, under driver side dash
SWI 1	B	~	24 pin	16	Green/Red	(DATA)	Behind radio
SWI 2	D	~	28 pin	02	Purple	(DATA)	Bluetooth unit, under center dash
SWI 3	H	~	16 pin	12	Gray	(DATA)	Behind Nav unit
SWI Feed	B	~	24 pin	05	Brown	(-)	Behind radio